

BUYERS GUIDE 2019



mares



Seventy wonderful years: driven by passion.

Ludovico Mares was the legend and founder of Mares diving. Ludovico's passion for diving created a spark of enthusiasm that has spread unchanged for 70 years, and generation to generation. For this reason, Mares is a leading company in the world of diving. Technology, quality, reliability and innovation: everything is inspired by passion. Passionate people allow us to achieve our ambitious goals and to set increasingly innovative objectives. Designing and creating state-of-the-art equipment, being the first to test innovations, and recognizing new things are secrets to our success. Everything we do aims to increase diving enjoyment through superior technology and advanced performance. **Working with passion is a great privilege.**

It's time to give back.

As divers ourselves, we love and respect the underwater world, including everything in it. This is a fundamental and core element of our passion; but the seas and oceans ask us to do more. The time has come to act. We have adopted concrete measures to reduce unnecessary plastic in our company, and share the message with employees, collaborators and suppliers. To safeguard what we love most, we must do our part to preserve all bodies of water, especially for those who follow in our footsteps, including future generations. Oceans need to be plastic free. **This is our commitment, and why we are part of MISSION DEEP BLUE.**



www.missiondeepblue.com



PURE INSTINCT

mares | 
pure instinct

mares | pure instinct



HORIZON 10

code: 422481 Man
code: 422482 Lady

- EXTREMELY THIN STEAMER, IDEAL FOR TRAINING AND COMPETITION IN A SWIMMING POOL
- NEW PREFORMED CUT ENSURES COMFORT AND EXCELLENT FIT
- DESIGNED TO AID ARM EXTENSION
- THE NEW SMOOTH NEOPRENE INCREASES HYDRODYNAMICS WHILE FREEDIVING
- SLIPPERY SMOOTH SURFACE IS ACHIEVED BY A POLYURETHANE TREATMENT
- EXCELLENT ELASTICITY AND HIGH THERMAL PROPERTIES
- REAR ZIPPER

APNEA INFINITY 30

code: 422463 Man
code: 422464 Lady

- NEW PREFORMED CUT ENSURES COMFORT AND EXCELLENT FIT
- DESIGNED TO AID ARM EXTENSION
- THE NEW SMOOTH NEOPRENE INCREASES HYDRODYNAMICS DURING FREEDIVING
- EXCELLENT ELASTICITY, HIGH THERMAL PROPERTIES AND COMPRESSION RESISTANT
- THE NEOPRENE'S SPECIAL TREATMENT INCREASES RESISTANCE TO TEARS
- ULTRA-STRETCH PANELS ON THE BASE OF THE ZIPPER AND IN THE UNDER ARM AREA
- REAR ZIPPER
- SEPARATE 3 mm HOOD (NOT INCLUDED)



FREEDIVING

TECHNICAL FEATURES

Thickness	1.0 mm					
Fabric type	POLYURETHANE TREATMENT					
	NEOPRENE					
	BLACK LINING INTERIOR					
Man Sizes	1	2	3	4	5	6
Lady Sizes	0	1	2	3	4	5

TECHNICAL FEATURES

Thickness	3.0 mm				
Fabric type	POLYURETHANE TREATMENT				
	NEOPRENE				
	BLACK LINING INTERIOR				
Man Sizes	2	3	4	5	6
Lady Sizes	1	2	3	4	5

APNEA INSTINCT

30 MAN

Jacket: **422475**

Pants: **422476**

50 MAN

Jacket: **422459**

Pants: **422460**

30 LADY

Jacket: **422477**

Pants: **422478**

50 LADY

Jacket: **422461**

Pants: **422462**

- NEW PREFORMED CUT ENSURES COMFORT AND EXCELLENT FIT
- STHE 5 mm JACKET UTILIZES 3.5 mm NEOPRENE AT THE WRISTS AND AROUND THE FACE, INCLUDING THE SAME APPLICATION ON THE PANTS AT THE ANKLES AND WAISTBAND
- HIGH-WAISTED PANTS
- RUGGED DOUBLE-LINED BEAVER TAIL WITH QUICK-CONNECT GROMMETS



TECHNICAL FEATURES

Thickness	3.0 mm / 5.0 mm					
Fabric type	BLACK LINING EXTERIOR					
	NEOPRENE					
	OPEN CELL INTERIOR					
Man Sizes	2	3	4	5	6	
Lady Sizes	1	2	3	4	5	

APNEA INSTINCT 17

MAN

Jacket code: **422468**

Pant code: **422469**

LADY

Jacket code: **422470**

Pant code: **422471**

- NEW PREFORMED CUT ENSURES COMFORT AND EXCELLENT FIT
- EXCELLENT ELASTICITY AND COMPRESSION RESISTANT NEOPRENE
- DEDICATED TO FREEDIVING COMPETITIONS IN WARM WATER CONDITIONS
- HIGH-WAISTED PANTS
- RUGGED DOUBLE-LINED BEAVER TAIL WITH QUICK-CONNECT GROMMETS



TECHNICAL FEATURES

Thickness	1.7 mm					
Fabric type	POLYURETHANE TREATMENT					
	NEOPRENE					
	BLACK LINING INTERIOR					
Man Sizes	2	3	4	5	6	
Lady Sizes	1	2	3	4	5	

RAZOR APNEA

code: **420410 SFT/MED**



- BLADE PRODUCED WITH PRE-IMPREGNATED FIBERGLASS LAYERS
- VARIABLE BLADE THICKNESS AND HIGH-PERFORMING PARABOLIC FLEXION
- THE BLADE IS 20.5 cm WIDE AND 65 cm LONG
- HIGH-QUALITY MANUFACTURING PROCESS
- NEW VARIABLE SIDE RIBS SUPPORT AND OPTIMIZE CHANNEL THRUST AND FLEX
- AVAILABLE WITH A SOFT OR MEDIUM STRENGTH WHITE BLADE
- 22° BLADE INCLINATION RELATIVE TO THE FOOT POCKET
- THE RAZOR FOOT POCKET IS DESIGNED TO BE WORN WITH A 3 mm NEOPRENE SOCK
- FIN PROTECTION BAG INCLUDED

TECHNICAL FEATURES

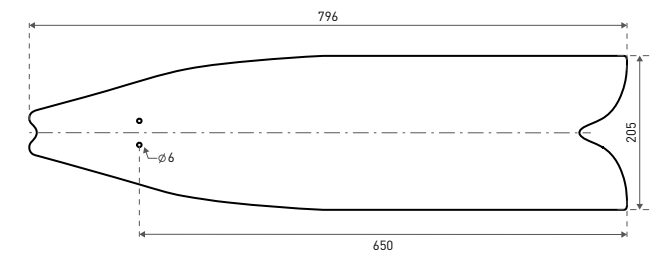

Sizes			Weight	Length
EU	UK	USA		
39/40	5.5/6.5	7/8	1032gr	900mm
41/42	7.5/8	8.5/9.5	1085gr	910mm
43/44	9/10	10/11	1135gr	930mm
45/46	10.5/11.5	12/13	1200gr	940mm
47/48	12/13	13/14	1240gr	950mm

SPARE PART

	code	page
Foot pocket Razor	420904	177
Blade Fixing set	420905	177
Blade Razor Apnea	420912	161

ACCESSORIES

	code	page
Razor fin insole	423943	177

BLADE RAZOR APNEA

code: **420912 SFT/MED**



MONOFIN RACE

code: 420414

- BLADE PRODUCED WITH PRE-IMPREGNATED FIBERGLASS LAYERS
- VARIABLE BLADE THICKNESS AND HIGH-PERFORMING PARABOLIC FLEXION
- HIGH-QUALITY MANUFACTURING PROCESS
- SIDE RIBS SUPPORT AND OPTIMIZE CHANNEL THRUST AND FLEX
- THE RACE FOOT POCKET IS DESIGNED FOR FREEDIVING COMPETITIONS



WH

BK

TECHNICAL FEATURES

Sizes			Weight	Length	Width	Hardness of fin blade
EU	UK	USA				
34/37	2/4.5	3/5	3100gr	730mm	715mm	K6
38/41	5/7.5	6/8	3150gr	740mm	715mm	K6
42/44	8/9.5	8.5/10.5	3200gr	750mm	715mm	K9
44/45	9.5/10.5	10.5/11.5	3250gr	760mm	715mm	K9

ATTACK MONOFIN

code: 425563

- A BAG FOR TRANSPORTING AND PROTECTING THE MARES RACE MONOFIN
- HORIZONTAL ZIP TO ACCESS THE FRONT POCKET
- ADJUSTABLE SHOULDER STRAP AND HANDLE ON SIDE



TECHNICAL FEATURES

Dimensions (LxWxH)	Unit Net Weight	Volume
77x68,5x19 cm	1,0 kg	100,2 L

HOOD INFINITY 30

code: 422465 Man

code: 422474 Lady

- NEW PREFORMED CUT ENSURES COMFORT AND EXCELLENT FIT
- DEDICATED TO THE NEW FREEDIVING STEAMERS



TECHNICAL FEATURES

Thickness	3.0 mm					
Fabric type	SMOOTH EXTERIOR					
	BLACK LINING INTERIOR					
Man Sizes		2	3	4	5	6
Lady Sizes	1	2	3	4	5	

SWIM APNEA CAP

code: 425868

- A SILICON SWIMMING CAP FOR FREEDIVING COMPETITIONS



COLLAR

code: 425864 Weight 300gr

code: 425865 Cordura Strap

code: 425866 Silicone Strap

- SOPHISTICATED FREEDIVING WEIGHT COLLAR SYSTEM
- 300g WEIGHTS WHICH CONNECT INDIVIDUALLY
- EASY WEIGHT ADJUSTMENT
- WHITE WEIGHTS FOR BETTER VISIBILITY AND NICE DESIGN
- TWO ADJUSTABLE STRAPS: CORDURA OR SILICONE
- BUCKLES ARE DESIGNED FOR SIMPLE AND INTUITIVE USE



NOSE CLIP

code: **423974**

- ERGONOMIC SHAPE FOR HANDS-FREE COMPENSATION
- LIGHT AND COMPACT
- SOFT OVER MOLDED AREA FOR MAXIMUM GRIP AND COMFORT
- CAN BE APPLIED ON THE MASK OR NOSE
- IDEAL FOR SWIMMING AND FREEDIVING IN ALL ENVIRONMENTS
- SYMMETRICALLY FORMED
- ADJUSTABLE LANYARD

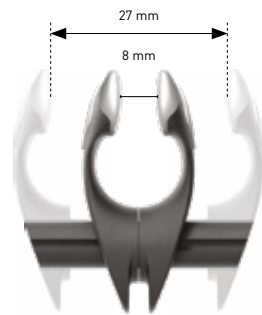

LANYARD FREEDIVING

code: **423992 - Lanyard Freediving**

code: **423995 - Lanyard Freediving with snap release**

- RELEASABLE SAFETY CABLE
- SAFETY RELEASE SYSTEM ON THE BRACELET
- STAINLESS STEEL SNAP HOOK
- COATED STEEL CABLE, YELLOW COLOR AND 100 cm LONG
- TWO SWIVELS AT THE EXTREMITIES OF THE CABLE
- THE LANYARD IS MANDATORY IN COMPETITION, AND RECOMMENDED DURING COURSES AND TRAINING



BELT ELASTIC W/NYLON BUCKLE

code: **425812 - WH**

code: **425812 - BK**

- QUICK-RELEASE NYLON BUCKLE
- 3 mm ELASTIC TAPE, 140 cm LONG



BELT ELASTIC W/MARSEILLAISE S.S.

code: **425813 - WH**

code: **425813 - BK**

- NEW STAINLESS STEEL, QUICK-RELEASE BUCKLE
- 3 mm ELASTIC TAPE, 140 cm LONG



TRAINING

code: **425715**

- FOUR OUTSIDE HANDLES FOR PRE-DIVE PREPARATION
- AMPLE INSIDE SPACE TO CONTAIN THE LINE DURING TRANSPORTATION
- EXTERNAL POCKET WITH ZIP
- ORAL INFLATOR AND OVER PRESSURE VALVE
- STAINLESS STEEL D-RING FOR TO CONNECT THE FREE DIVING LINE
- RESISTANT MESH PANELS AND SIX 12 mm HOLES FOR WATER DRAINAGE
- DIVE FLAG (CODE: 45200301) AND FLAG SUPPORT (CODE: 425716) NOT INCLUDED



TECHNICAL FEATURES

Width	Height	Volume of internal air
70 cm	17 cm	48 L

DIVE FLAG 30,5 x 30,5 cm

code: **45200301**

- FLAG SIZE: 30.5 X 30.5 cm
- CAN BE MOUNTED ON 425717, 425720 AND 425715



HOLDER

code: **425716**

- CAN BE MOUNTED ON 425717, 425720 AND 425715
- ONLY FOR USE WITH FLAG CODE 45200301



BOTTOM PLATE

code: **425814**

- THE BEST FREEDIVING BOTTOM PLATE FOR TRAINING AND COMPETITIONS
- DESIGNED FOR USE WITH Ø 10mm FREEDIVING LINE
- OPTIMAL HYDRODYNAMIC PERFORMANCE THANKS TO ITS SHAPE AND HOLES FOR WATER
- Ø 27cm WHITE PLATE FOR GREAT VISIBILITY FROM A DISTANCE
- CONNECTION HOLES AVAILABLE:
2 FOR ACTION CAMS - 16 FOR VELCRO NAME TAG STRIPS - 32 FOR DEPTH TAGS



NEW

SMART APNEA**NEW**

code: 424153

- SEGMENTED LCD DISPLAY
- INSTANTANEOUS DEPTH, DIVE TIME, RECOVERY TIME, TEMPERATURE
- DESCENT AND ASCENT RATE
- CUSTOMIZABLE ALARMS (DEPTH, TIME, SPEED, HYDRATION, RECOVERY TIME)
- ONE SECOND SAMPLING RATE
- ADVANCED PERFORMANCE MICROPROCESSOR
- LATEST GENERATION DEPTH SENSOR
- UPDATABLE FIRMWARE AND DATA DOWNLOAD WITH AFTERMARKET DIVE LINK INTERFACE

ALSO FOR FREEDIVING **COLOR VARIATIONS**

BKWH

BKBL

BKGR

BKOR

DISPLAYS (Scale 1:1)

Time mode



Surface display

TECHNICAL FEATURES

Battery	Type	CR2430
	Duration	Approx. 200 hours of diving over a 2 year time span
Max displayed depth	150m/492ft	
Resolution	Resolution 0.1m until 99.9m - 1m at depth deeper than 100m In ft. it is always 1ft	
Temperature	-10 °C to +50 °C / 14 °F to 122 °F	
Logbook memory	20-30 hours of dive profile at 1-second sampling rate	
Display	Mineral glass - Diagonal 31 mm / 1 ¼ inch	
Clock	Quartz clock, time, date, dive time, displays up to 999 minutes	

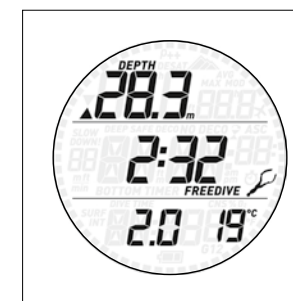

Dive mode



Programmable alarm

COMPUTERS

BLUELINK PRO

code: 414317

- TO DOWNLOAD THE LOGBOOK OF A DIVE COMPUTER USING THE BLUETOOTH LOW ENERGY TECHNOLOGY
- REQUIRES THE DIVESSI APP (ANDROID, IOS)

**DIVE LINK 2 USB**

code: 414316

- FOR DOWNLOADING THE DIVE COMPUTER MEMORY TO PC OR MAC
- REQUIRED SOFTWARE: DIVE ORGANIZER (PC) OR DIVERS DIARY (MAC)

**DISPLAY PROTECTOR**

code: 415173

- PERFECT FIT AND EASY TO INSTALL
- PREVENTS FROM SCRATCHES, DIRT AND SAND
- SOFT AND DURABLE
- ULTRA CLEAR
- A PACK CONTAINS 2 PIECES

**MISSION DIGITAL CHRONO SF**

code: 424154

- DIGITAL CHRONOGRAPH WITH BACK LIGHT
- DEPTH RATED TO 200 m/660 ft
- HIGH-QUALITY SWISS QUARTZ MOVEMENT
- DAILY ALARM AND HOURLY TIME SIGNAL
- COUNTDOWN TIMER
- DIGITAL TIMEZONE AND DATE
- SECOND DIGITAL TIMEZONE
- FLUORESCENT DIGITS
- STAINLESS STEEL
- ADJUSTABLE STRAP

**SOFTWARE****DIVE ORGANIZER**

- FULL-FEATURED LOGBOOK MANAGEMENT SOFTWARE
- FOR PC ONLY

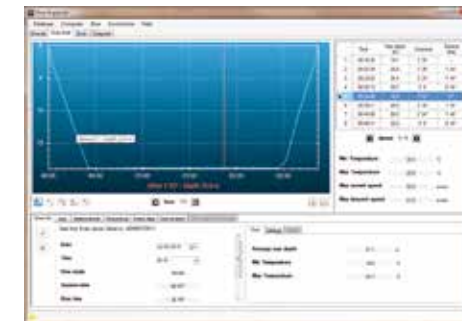
**DIVERS DIARY**

- FULL-FEATURED LOGBOOK MANAGEMENT SOFTWARE
- FOR MAC ONLY

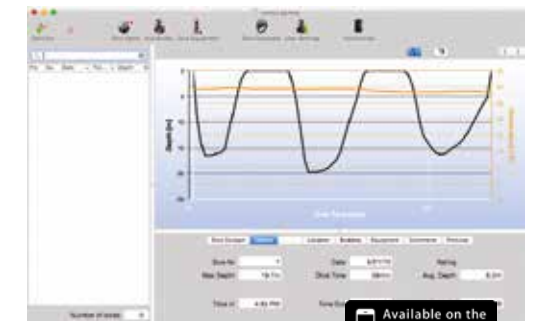

Available on the App Store

RAZOR MATRIX

code: 420409 SFT/MED



FINS



- BLADE PRODUCED WITH PRE-IMPREGNATED CARBON AND FIBERGLASS LAYERS
- NEW 3K CARBON WITH FIBERS WOVEN AT 90°
- FIBERS CROSS OVER EACH OTHER FEWER TIMES, INCREASING THE RESPONSIVENESS OF THE BLADE
- VARIABLE BLADE THICKNESS AND HIGH-PERFORMING PARABOLIC FLEXION
- THE BLADE IS 20.5 cm WIDE AND 65 cm LONG
- HIGH-QUALITY MANUFACTURING PROCESS
- NEW VARIABLE SIDE RIBS SUPPORT AND OPTIMIZE CHANNEL THRUST AND FLEX
- AVAILABLE WITH A SOFT OR MEDIUM STRENGTH BLADE
- 22° BLADE INCLINATION RELATIVE TO THE FOOT POCKET
- THE RAZOR FOOT POCKET IS DESIGNED TO BE WORN WITH A 3 mm NEOPRENE SOCK
- FIN PROTECTION BAG INCLUDED

ALSO FOR FREEDIVING

TECHNICAL FEATURES

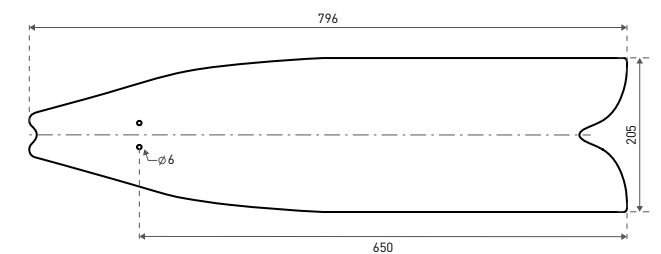

Sizes			Weight	Length
EU	UK	USA		
39/40	5.5/6.5	7/8	962gr	900mm
41/42	7.5/8	8.5/9.5	1015gr	910mm
43/44	9/10	10/11	1065gr	930mm
45/46	10.5/11.5	12/13	1130gr	940mm
47/48	12/13	13/14	1170gr	950mm

SPARE PART

	code	page
Foot pocket Razor	420904	177
Blade Fixing set	420905	177
Blade Razor Matrix	420911	176

ACCESSORIES

Razor fin insole	423943	177
------------------	--------	-----

RAZOR C740

code: 420411 SFT/MED



- BLADE PRODUCED WITH PRE-IMPREGNATED CARBON AND FIBERGLASS LAYERS
- NEW 3K CARBON WITH FIBERS WOVEN AT 90°
- FIBERS CROSS OVER EACH OTHER FEWER TIMES, INCREASING THE RESPONSIVENESS OF THE BLADE
- VARIABLE BLADE THICKNESS AND HIGH-PERFORMING PARABOLIC FLEXION
- THE BLADE IS 21 cm WIDE AND 59 cm LONG
- HIGH-QUALITY MANUFACTURING PROCESS
- NEW VARIABLE SIDE RIBS SUPPORT AND OPTIMIZE CHANNEL THRUST AND FLEX
- AVAILABLE WITH A SOFT OR MEDIUM STRENGTH BLADE
- 22° BLADE INCLINATION RELATIVE TO THE FOOT POCKET
- THE RAZOR FOOT POCKET IS DESIGNED TO BE WORN WITH A 3 mm NEOPRENE SOCK
- FIN PROTECTION BAG INCLUDED

ALSO FOR FREEDIVING

TECHNICAL FEATURES

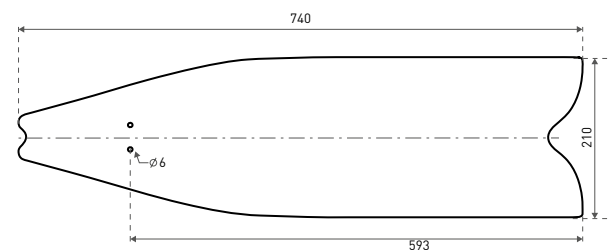

Sizes			Weight	Length
EU	UK	USA		
39/40	5.5/6.5	7/8	912gr	843mm
41/42	7.5/8	8.5/9.5	965gr	853mm
43/44	9/10	10/11	1015gr	873mm
45/46	10.5/11.5	12/13	1080gr	883mm
47/48	12/13	13/14	1120gr	893mm

SPARE PART

	code	page
Foot pocket Razor	420904	177
Blade Fixing set	420905	177
Blade Razor C740	420913	176

ACCESSORIES

Razor fin insole	423943	177
------------------	--------	-----

RAZOR ILLUSION

code: 420413



- BLADE PRODUCED WITH PRE-IMPREGNATED FIBERGLASS LAYERS
- CONSTANT BLADE THICKNESS IN ILLUSION CAMOUFLAGE COLOR FOR OPTIMAL FISHING POTENTIAL
- THE BLADE IS 22 cm WIDE AND 59 cm LONG
- HIGH-QUALITY MANUFACTURING PROCESS
- NEW VARIABLE SIDE RIBS SUPPORT AND OPTIMIZE CHANNEL THRUST AND FLEX
- 22° BLADE INCLINATION RELATIVE TO THE FOOT POCKET
- THE RAZOR FOOT POCKET IS DESIGNED TO BE WORN WITH A 3 mm NEOPRENE SOCK
- FIN PROTECTION BAG INCLUDED

TECHNICAL FEATURES

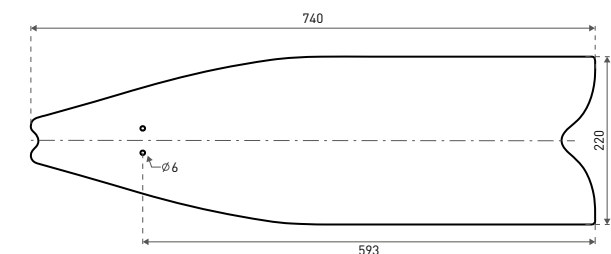

Sizes			Weight	Length
EU	UK	USA		
39/40	5.5/6.5	7/8	1027gr	843mm
41/42	7.5/8	8.5/9.5	1080gr	853mm
43/44	9/10	10/11	1130gr	873mm
45/46	10.5/11.5	12/13	1195gr	883mm
47/48	12/13	13/14	1235gr	893mm

SPARE PART

	code	page
Foot pocket Razor	420904	177
Blade Fixing set	420905	177
Blade Razor Illusion	420915	176

ACCESSORIES

Razor fin insole	423943	177
------------------	--------	-----

RAZOR F740

code: 420412



- BLADE PRODUCED WITH PRE-IMPREGNATED FIBERGLASS LAYERS
- CONSTANT BLADE THICKNESS
- THE BLADE IS 22 cm WIDE AND 59 cm LONG
- HIGH-QUALITY MANUFACTURING PROCESS
- NEW VARIABLE SIDE RIBS SUPPORT AND OPTIMIZE CHANNEL THRUST AND FLEX
- 22° BLADE INCLINATION RELATIVE TO THE FOOT POCKET
- THE RAZOR FOOT POCKET IS DESIGNED TO BE WORN WITH A 3 mm NEOPRENE SOCK
- FIN PROTECTION BAG INCLUDED

ALSO FOR FREEDIVING

TECHNICAL FEATURES

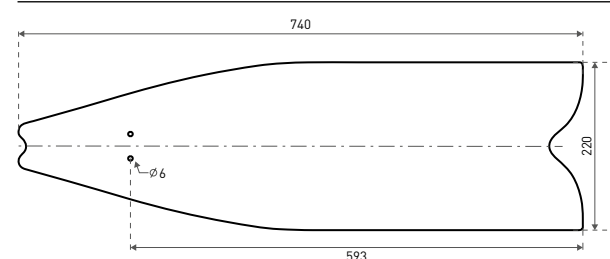

Sizes			Weight	Length
EU	UK	USA		
39/40	5.5/6.5	7/8	1012gr	843mm
41/42	7.5/8	8.5/9.5	1065gr	853mm
43/44	9/10	10/11	1115gr	873mm
45/46	10.5/11.5	12/13	1180gr	883mm
47/48	12/13	13/14	1220gr	893mm

SPARE PART

	code	page
Foot pocket Razor	420904	177
Blade Fixing set	420905	177
Blade Razor F740	420914	176

ACCESSORIES

Razor fin insole	423943	177
------------------	--------	-----

RAZOR PRO

code: 420401



- INTERCHANGEABLE BLADE TO MEET DEMANDS IN ALL DIVING CONDITIONS
- TAPERED HIGH-QUALITY ELASTOMER BLADE FACILITATES EXCELLENT AGILITY AND PERFORMANCE
- DESIGNED TO BE WORN WITH A 3 mm NEOPRENE SOCK
- PERFORMANCE ENGINEERED FOOT POCKET DELIVERS PERFECT POWER TRANSMISSION FROM FOOT TO BLADE
- V-TIP TO PREVENT SLIPPING FROM SIDE TO SIDE WHILE KICKING

ALSO FOR FREEDIVING

TECHNICAL FEATURES

Sizes			Weight	Length
EU	UK	USA		
39/40	5.5/6.5	7/8	1035gr	870mm
41/42	7.5/8	8.5/9.5	1095gr	880mm
43/44	9/10	10/11	1145gr	900mm
45/46	10.5/11.5	12/13	1210gr	910mm
47/48	12/13	13/14	1250gr	920mm

SPARE PART

	code	page
Foot pocket Razor	420904	177
Blade Fixing set	420905	177
Fin Blade Razor Pro Black	420901	176

ACCESSORIES

Razor fin insole	423943	177
------------------	--------	-----

RAZOR

code: 420402



- IDEAL CHOICE FOR SHALLOW TO MID-DEPTH DIVING
- 30% SOFTER BLADE VERSUS RAZOR PRO
- BEST CHOICE FOR EXTENDED SURFACE SWIMMING
- DESIGNED TO BE WORN WITH A 3 mm NEOPRENE SOCK
- INTERCHANGEABLE BLADE CONSTRUCTION

ALSO FOR FREEDIVING

TECHNICAL FEATURES

Sizes			Weight	Length
EU	UK	USA		
39/40	5.5/6.5	7/8	1028gr	870mm
41/42	7.5/8	8.5/9.5	1088gr	880mm
43/44	9/10	10/11	1138gr	900mm
45/46	10.5/11.5	12/13	1203gr	910mm
47/48	12/13	13/14	1243gr	920mm

SPARE PART

	code	page
Foot pocket Razor	420904	177
Blade Fixing set	420905	177
Blade Razor Grey	420902	176

ACCESSORIES

Razor fin insole	423943	177
------------------	--------	-----

RAZOR BLADES

BLADE RAZOR MATRIX

code: 420911 SFT/MED

BLADE RAZOR C740

code: 420913 SFT/MED

BLADE RAZOR ILLUSION

code: 420915

BLADE RAZOR F740

code: 420914

BLADE RAZOR PRO BLACK

code: 420901

BLADE RAZOR PRO CAMOUFLAGE GREEN

code: 420906

BLADE RAZOR PRO CAMOUFLAGE BROWN

code: 420907

BLADE RAZOR GREY

code: 420902



TECHNICAL FEATURES

Pack info	Sold singly
-----------	-------------

RAZOR FOOT POCKET

code: 420904

- DESIGNED TO BE WORN WITH A 3mm NEOPRENE SOCK
- WEARING THESE FINS BAREFOOT, USE THE NEXT SIZE SMALLER FINS
- PACK INFO: SOLD SINGLY



TECHNICAL FEATURES

Sizes	39/40 - 41/42 - 43/44 - 45/46 - 47/48
-------	---------------------------------------

RAZOR BLADE FIXING SET

code: 420905

- PACK INFO: SOLD SINGLY



RAZOR INSOLE

code: 423943

- PREFORMED INSOLE CAN MAKE A RAZOR FOOT POCKET ONE SIZE SMALLER
- USE SCISSORS TO CUT ALONG THE LINES PROVIDED ON THE UNDERSIDE
- THE LENGTH CAN BE ADJUSTED TO THREE DIFFERENT SIZES
- PACK 5 PCS (RETAIL PRICE FOR 1 PC)



SIZES

A	+EU 39/40	=EU 37/38	=UK 4.5/5	=USA 5/6
B	+EU 41/42	=EU 40/41	=UK 6.5/7.5	=USA 7/8
C	+EU 43/44	=EU 42/43	=UK 8/9	=USA 8.5/9.5
C	+EU 45/46	=EU 44/45	=UK 10/10.5	=USA 10/11

AVANTI QUATTRO POWER

code: 420404

- MARES CHANNEL THRUST PATENT
- OPTIMIZED WATER CHANNELING FOR SIGNIFICANT FLOW AND THRUST
- SHORTER BLADE FOR INCREASED CONTROL AND FAST MANEUVERS IN AND UNDER WATER
- ANATOMIC FOOT POCKET WITH REINFORCED HEEL



TECHNICAL FEATURES

Sizes			Weight	Length
EU	UK	USA		
40/41	6.5/7.5	7/8	960gr	710mm
42/43	8/9	8.5/9.5	1053gr	725mm
44/45	10/10.5	10/11	1175gr	755mm
46/47	11.5/12	12/13	1210gr	765mm

CONCORDE

code: 420406

- IDEAL CHOICE FOR SHALLOW TO MID-DEPTH DIVING
- NEW TECHNO POLYMER BLADE AND HIGH-PERFORMANCE PARABOLIC FLEXION
- OVER MOLDED FOOT POCKET
- TAPERED LATERAL RIPS FOR PROGRESSIVE BLADE FLEX
- NEW TIP PROFILE TO PREVENT SLIPPING FROM SIDE TO SIDE WHILE KICKING



ALSO FOR FREEDIVING

COLOR VARIATIONS



TECHNICAL FEATURES

Sizes			Weight	Length
EU	UK	USA		
38/39	5/6	6/7	904gr	860mm
40/41	6.5/7.5	7/8	932gr	874mm
42/43	8/9	8.5/9.5	968gr	889mm
44/45	10/10.5	10/11	1002gr	902mm
46/47	11.5/12	12/13	1027gr	916mm

DETAILS

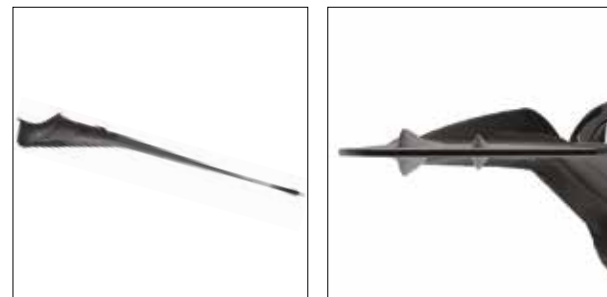

Fins*	Razor Matrix	Razor C740	Razor Illusion	Razor F740	Razor Pro	Razor	Avanti Quattro Power	Concorde
Code	420409 SFT/MED	420411 SFT/MED	420413	420412	420401 BK	420402 GR	420404 CM	420406 BK 420406 BWN 420406 GN
SIZES								
EU	UK	USA						
38/39	5/6	6/7						904gr - 860mm
39/40	5.5/6.5	7/8	962gr - 900mm	912gr - 843mm	1027gr - 843mm	1012gr - 843mm	1035gr - 870mm	1028gr - 870mm
40/41	6.5/7.5	7/8						960gr - 710mm
41/42	7.5/8	8.5/9.5	1015gr - 910mm	965gr - 853mm	1080gr - 853mm	1065gr - 853mm	1095gr - 880mm	1088gr - 880mm
42/43	8/9	8.5/9.5						1053gr - 725mm
43/44	9/10	10/11	1065gr - 930mm	1015gr - 873mm	1130gr - 873mm	1115gr - 873mm	1145gr - 900mm	1138gr - 900mm
44/45	10/10.5	10/11						1175gr - 755mm
45/46	10.5/11.5	12/13	1130gr - 940mm	1080gr - 883mm	1195gr - 883mm	1180gr - 883mm	1210gr - 910mm	1203gr - 910mm
46/47	11.5/12	12/13						1210gr - 765mm
47/48	12/13	13/14	1170gr - 950mm	1120gr - 893mm	1235gr - 893mm	1220gr - 893mm	1250gr - 920mm	1243gr - 920mm

* The data refer to blades mounted on Razor foot pockets. Razor foot pockets are designed to be worn with a 3mm neoprene sock. If you are wearing these fins barefoot, use the next size smaller fins.



X-FREE

code: 421412

- OVER MOLDED FRAME AND ANATOMICAL SKIRT
- MINIMUM DISTANCE BETWEEN LENS AND EYES
- MINIMAL INTERNAL VOLUME, UNDER 80cm³
- INCREASED FIELD OF VISION
- VERY LIGHTWEIGHT
- MATTE FINISH FOR ANTI-REFLECTIVE PROPERTIES
- HYDRODYNAMIC PROFILE REDUCES DRAG IN WATER
- ERGONOMIC MASK STRAP BUCKLES FOR EASY OPERATION
- EMBOSSED GRIP AREA ON THE NOSE FOR PERFECT FITTING WITH A NOSE CLIP
- NEW SILICONE UTILIZED IN THE SKIRT REDUCES FOGGING



ALSO FOR FREEDIVING

COLOR VARIATIONS



BXBK BK BXBWN BK BXGN BK BXBL BL BXWH BK BXWH GR

TECHNICAL FEATURES

Weight (g)	147 gr
------------	--------

BUCKLE



DETAILS



MASKS & SNORKELS

SAMURAI X

code: 421413

- RESTYLING OF THE HISTORICAL SAMURAI MASK
- REDUCED DISTANCE FROM LENS TO EYES
- MINIMAL INTERNAL VOLUME, UNDER 80 cm³
- WIDE FIELD OF VISION
- NEW LIGHTWEIGHT THIN FRAME
- MATTE FINISH FOR ANTI-REFLECTIVE PROPERTIES
- BUCKLE CONNECTIONS ON THE SKIRT



ALSO FOR FREEDIVING

COLOR VARIATIONS



BXBK BK BXBWN BK BXGN BK

TECHNICAL FEATURES

Weight (g)	140 gr
------------	--------

BUCKLE



VIPER

code: 421411

- REDUCED DISTANCE FROM LENS TO EYE
- MINIMAL INTERNAL VOLUME
- INCREASED FIELD OF VISION
- ANATOMICAL SKIRT WITHOUT INTERNAL LIP
- VERY LIGHTWEIGHT
- MATTE FINISH FOR ANTI-REFLECTIVE PROPERTIES
- HYDRODYNAMIC PROFILE REDUCING RESISTANCE IN WATER
- ERGONOMIC MASK STRAP BUCKLES FOR EFFORTLESS OPERATION
- THE NEW SILICONE USED IN SKIRT REDUCES FOGGING



ALSO FOR FREEDIVING

COLOR VARIATIONS



BXBK BK BXBWN BK BXGN BK BXBL BL BXWH WH

TECHNICAL FEATURES

Weight (g)	150 gr
------------	--------

BUCKLE

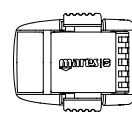

STAR LIQUIDSKIN

code: 421400

- BI-SILICONE SKIRT AND STRAP, EXCLUSIVE MARES LIQUIDSKIN © PATENT
- MINIMAL INTERNAL VOLUME
- REDUCED DISTANCE FROM LENS TO EYE
- INCREASED FIELD OF VISION
- LOW PROFILE BUCKLES POSITIONED ON THE SKIRT



ALSO FOR FREEDIVING

COLOR VARIATIONS



BXBK GR BXBK AG

TECHNICAL FEATURES

Weight (g)	149 gr
------------	--------

ACCESSORIES

Optical lens (from -1,0 to -5,0)	421100
----------------------------------	--------

BUCKLE

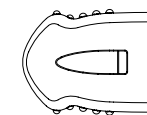

SEALHOUETTE

NEW

code: 421414

- BI-LENS MASK
- SILICONE SKIRT
- REDUCED DISTANCE BETWEEN LENSES AND EYES
- AMPLE FIELD OF VISION
- LIGHTWEIGHT
- SOFT TOUCH SILICONE BUCKLES
- BUCKLES ON SKIRT



ALSO FOR FREEDIVING

COLOR VARIATIONS



BXBK BK BXMBK BK BXMBL BK

TECHNICAL FEATURES

Weight (g)	161 gr
------------	--------

BUCKLE

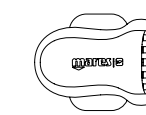

STAR

code: 421402

- MINIMAL INTERNAL VOLUME
- REDUCED DISTANCE FROM LENS TO EYE
- INCREASED FIELD OF VISION
- LOW PROFILE BUCKLES POSITIONED ON THE SKIRT



ALSO FOR FREEDIVING

COLOR VARIATIONS



BXBK BK BXXM BK

TECHNICAL FEATURES

Weight (g)	145 gr
------------	--------

ACCESSORIES

Optical lens (from -1,0 to -5,0)	421100
----------------------------------	--------

BUCKLE

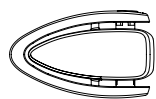

STAR ELITE

code: 421401

- ANTI-REFLECTIVE LENS TREATMENT (MIRRORED)
- MINIMAL INTERNAL VOLUME
- REDUCED DISTANCE FROM LENS TO EYE
- INCREASED FIELD OF VISION
- LOW PROFILE BUCKLES POSITIONED ON THE SKIRT



ALSO FOR FREEDIVING

COLOR VARIATIONS



BXBK BK

TECHNICAL FEATURES

Weight (g)	145 gr
------------	--------

BUCKLE

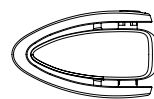

TANA

code: 421405

- SOFT TOUCH INSERTS ON THE FRAME FOR A SURE GRIP AND EASY POSITIONING ON THE FACE
- REDUCED DISTANCE FROM LENS TO EYE
- OPTIMUM FIELD OF VISION
- REDUCED INTERNAL VOLUME
- LIGHTWEIGHT
- SIDE GUSSETS AT THE NOSE TO FACILITATE EASY EQUALIZING



ALSO FOR FREEDIVING

COLOR VARIATIONS



BXBK BK BXGN BK BXBL BK BXBWN BK

TECHNICAL FEATURES

Weight (g)	155 gr
------------	--------

BUCKLE



SET TANA

code: 411734

- MASK
 - SILICONE SKIRT
 - LOW INTERNAL VOLUME
 - BUCKLES ON SKIRT
- SNORKEL
 - BI-MATERIAL SNORKEL
 - CURVED, ERGONOMIC STRUCTURE
 - SLIDING KEEPER
 - SILICONE MOUTHPIECE FOR EXTENDED USE



ALSO FOR FREEDIVING

BUCKLE



DUAL CAMO

NEW

code: 421457

- TUBE IS MADE IN SOFT PVC IN A BLACK CAMOUFLAGE DESIGN
- ANATOMICAL MOUTHPIECE IN HYPOALLERGENIC SILICONE
- DIAMETER AND LENGTH OF TUBE ARE OPTIMIZED FOR EASIER CLEARING AND TO AVOID AIR TURBULENCE
- SPECIAL "D" SHAPED BARREL DESIGN ELIMINATES DISCOMFORT IN THE AREA OF THE TEMPLE

COLOR VARIATIONS



DUAL

code: 421454

- TUBE IS MADE FROM TWO MATERIALS WITH TWO DIFFERENT SOFTNESS LEVELS
- IDEAL FOR PROLONGED USE
- ANATOMICAL MOUTHPIECE IN HYPOALLERGENIC SILICONE
- DIAMETER AND LENGTH OF TUBE ARE OPTIMIZED FOR EASIER CLEARING AND TO AVOID AIR TURBULENCE
- SPECIAL "D" SHAPED BARREL DESIGN ELIMINATES DISCOMFORT IN THE AREA OF THE TEMPLE

ALSO FOR FREEDIVING

COLOR VARIATIONS

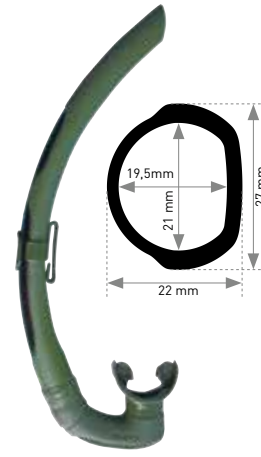

DUAL BASIC

code: 421455

- IDEAL FOR PROLONGED USE
- ANATOMICAL MOUTHPIECE IN HYPOALLERGENIC SILICONE
- DIAMETER AND LENGTH OF TUBE ARE OPTIMIZED FOR EASIER CLEARING AND TO AVOID AIR TURBULENCE
- SPECIAL "D" SHAPED BARREL DESIGN ELIMINATES DISCOMFORT IN THE AREA OF THE TEMPLE

COLOR VARIATIONS



ELEMENT

code: 421456

- SOFT TUBE
- DIAMETER AND LENGTH OF TUBE ARE OPTIMIZED FOR NATURAL EFFORTLESS BREATHING
- HYPOALLERGENIC SILICONE MOUTHPIECE

ALSO FOR FREEDIVING

COLOR VARIATIONS



SAMURAI EXTREM

code: 421450

- SOFT TUBE
- IDEAL FOR PROLONGED USE
- ANATOMICAL MOUTHPIECE IN HYPOALLERGENIC SILICONE
- DIAMETER AND LENGTH OF TUBE ARE OPTIMIZED FOR EASIER CLEARING AND TO AVOID AIR TURBULENCE

ALSO FOR FREEDIVING

COLOR VARIATIONS



SAMURAI

code: 421451

- IDEAL FOR PROLONGED USE
- ANATOMICAL MOUTHPIECE IN HYPOALLERGENIC SILICONE
- DIAMETER AND LENGTH OF TUBE ARE OPTIMIZED FOR EASIER CLEARING AND TO AVOID AIR TURBULENCE

ALSO FOR FREEDIVING

COLOR VARIATIONS



TECHNICAL SPECIFICATIONS



Mask	x Free	Samurai X	Viper	Star LiquidSkin®	Sealhouette	Star	Star Elite	Tana
Code	421412	421413	421411	421400	421414	421402	421401	421405
Color	BXBK BK	BXBK BK	BXBK BK	BXBK AG	BXBK BK	BXBK BK	BXBK BK	BXBK BK
	BXBWN BK	BXBWN BK	BXBWN BK	BXBK GR	BXMBK BK	BXCM BK		BXBWN BK
	BXGN BK	BXGN BK	BXGN BK		BXMBL BK			BXBL BK
	BXBL BL		BXBL BL					BXGN BK
	BXWH BK		BXWH WH					
Optional Optical lenses (Code 421100 from -1 to -5)				■		■		
Streamlined profile	■		■					
Light weight	■	■	■					
Wide field of vision	■	■	■		■			■
Internal Volume	Minimal	■	■	■	■	■	■	
	Reduced							■

M3RGE

NEW

50

Jacket: **422497**

Pants: **422498**

- NEW THREE-MATERIAL DESIGN - ELASTIC FABRIC BETWEEN TWO NEOPRENE LAYERS
- INNER FABRIC OFFERS HIGH RESISTANCE WITH THE SMOOTH / OPEN CELL NEOPRENE OFFERING THERMAL, ELASTIC AND HYDRODYNAMIC BENEFITS
- A PREFORMED CUT ENSURES COMFORT AND EXCELLENT FIT
- BLACK CAMOUFLAGE PANELS DISGUISE THE SHAPE OF THE FISHERMAN
- SOFTER BORDER WITH FOLDED SMOOTH NEOPRENE ON THE WAIST, WRISTS AND ANKLES
- NEW LARGE, ANTI-SLIP CHEST PAD WITH A NEOPRENE "SHOCK ABSORBER" INSIDE AND NEW REINFORCED KNEE PADS
- JACKET WITH ANTI-SLIP PADS ON THE BACK FOR A WEIGHT BELT



TECHNICAL FEATURES

Thickness	5,0 mm				
Fabric type	NEOPRENE THICKNESS	SMOOTHER OUTER STRETCH FABRIC			
		OPEN CELL INSIDE			
Sizes	2	3	4	5	6

DETAILS



NEOPRENE

EXPLORER CAMO BLACK

30
Jacket: 422040
Pants: 422041

50
Jacket: 422038
Pants: 422039

70
Jacket: 422037

- NEW BLACK CAMOUFLAGE PRINTED ON A GREY LINING HELPS TO DISGUISE THE SPEARFISHER
- A PREFORMED CUT ENSURES COMFORT AND EXCELLENT FIT
- EXCELLENT ELASTICITY, HIGH THERMAL PROPERTIES AND COMPRESSION RESISTANT
- ANTI-SLIP CHEST PAD AND NEOPRENE "SHOCK ABSORBER" INSIDE
- REINFORCED KNEE PADS



TECHNICAL FEATURES

Thickness	3.0 / 5.0 / 7.0 mm				
Fabric type	LINING EXTERIOR				
	NEOPRENE				
	OPEN CELL INTERIOR				
Sizes	2	3	4	5	6

DETAILS



SQUADRA ILLUSION BWN

NEW

50
Jacket: 422495
Pants: 422496

- ILLUSION BWN COLOR PRINTED ON A BEIGE LINING FOR THE BEST CAMOUFLAGE
- A PREFORMED CUT ENSURES COMFORT AND EXCELLENT FIT
- EXCELLENT ELASTICITY, HIGH THERMAL PROPERTIES AND COMPRESSION RESISTANT
- STITCHED FINISHING ON WAIST, WRISTS AND ANKLES
- NEW LARGE, ANTI-SLIP CHEST PAD WITH A NEOPRENE "SHOCK ABSORBER" INSIDE AND NEW REINFORCED KNEE PADS



TECHNICAL FEATURES

Thickness	5.0 mm				
Fabric type	LINING EXTERIOR				
	NEOPRENE				
	OPEN CELL INTERIOR				
Sizes	2	3	4	5	6

DETAILS



ILLUSION BWN

30

Jacket: **422035**
Pants: **422036**

50

Jacket: **422033**
Pants: **422034**

70

Jacket: **422032**

- NEW OCEAN FLOOR CAMOUFLAGE PRINTED ON A BEIGE LINING MASKS THE DIVER
- A PREFORMED CUT ENSURES COMFORT AND EXCELLENT FIT
- EXCELLENT ELASTICITY, HIGH THERMAL PROPERTIES AND COMPRESSION RESISTANT
- ANTI-SLIP CHEST PAD AND NEOPRENE "SHOCK ABSORBER" INSIDE
- REINFORCED KNEE PADS



TECHNICAL FEATURES

Thickness	3.0 mm / 5.0 mm / 7.0 mm				
Fabric type	LINING EXTERIOR				
	NEOPRENE				
	OPEN CELL INTERIOR				
Sizes	2	3	4	5	6

DETAILS



ILLUSION

30

Jacket: **422487**
Pants: **422488**

50

Jacket: **422484**
Pants: **422485**

Long John: **422486**

70

Jacket: **422483**

- NEW OCEAN FLOOR CAMOUFLAGE PRINTED ON A GREY LINING MASKS THE DIVER
- A PREFORMED CUT ENSURES COMFORT AND EXCELLENT FIT
- EXCELLENT ELASTICITY, HIGH THERMAL PROPERTIES AND COMPRESSION RESISTANT
- ANTI-SLIP CHEST PAD AND NEOPRENE "SHOCK ABSORBER" INSIDE
- REINFORCED KNEE PADS



TECHNICAL FEATURES

Thickness	3.0 mm / 5.0 mm / 7.0 mm				
Fabric type	LINING EXTERIOR				
	NEOPRENE				
	OPEN CELL INTERIOR				
Sizes	2	3	4	5	6

DETAILS



SQUADRA

35

Jacket: **422452**

Pants: **422453**

55

Jacket: **422449**

Pants: **422450**

Long John: **422451**

70

Jacket: **422454**

Pants: **422455**

- NEW PREFORMED CUT ENSURES COMFORT AND EXCELLENT FIT
- EXCELLENT ELASTICITY, HIGH THERMAL PROPERTIES, AND COMPRESSION RESISTANT
- BORDER OF SOFT, FOLDED NEOPRENE ON WAIST, WRIST AND ANKLES
- ANTI-SLIP CHEST PAD AND 2 NEOPRENE SHOCK ABSORBERS INSIDE
- REINFORCED KNEE PADS



TECHNICAL FEATURES

Thickness	3.5 / 5.5 / 7.0 mm				
Fabric type	BLACK LINING EXTERIOR				
	NEOPRENE				
	OPEN CELL INTERIOR				
Sizes	2	3	4	5	6

EXPLORER

30

Jacket: **422479**

Pants: **422480**

50

Jacket: **422456**

Pants: **422457**

Long John: **422458**

70

Jacket: **422472**

Pants: **422473**

- NEW PREFORMED CUT ENSURES COMFORT AND EXCELLENT FIT
- EXCELLENT ELASTICITY, HIGH THERMAL PROPERTIES AND COMPRESSION RESISTANT
- ANTI-SLIP CHEST PAD AND NEOPRENE "SHOCK ABSORBER" INSIDE
- REINFORCED KNEE PADS



TECHNICAL FEATURES

Thickness	3.0 mm / 5.0 mm / 7.0 mm				
Fabric type	BLACK LINING EXTERIOR				
	NEOPRENE				
	OPEN CELL INTERIOR				
Sizes	2	3	4	5	6

EXPLORER SPORT

50

Jacket: **422466**

Long John: **422467**

- NEW PREFORMED CUT ENSURES COMFORT AND EXCELLENT FIT
- ELASTICITY, COMFORTABLE, COMPRESSION RESISTANT AND EASY TO WEAR
- ANTI-SLIP CHEST PAD AND NEOPRENE "SHOCK ABSORBER" INSIDE
- REINFORCED KNEE PADS



TECHNICAL FEATURES

Thickness	5.0 mm				
Fabric type	BLACK LINING EXTERIOR				
	NEOPRENE				
	BLACK LINING INTERIOR				
Sizes	2	3	4	5	6

RASH GUARD

Top Illusion: **422489**

Pants Illusion: **422490**

- PROTECTION AGAINST UV RAYS AND UNDESIRABLE ENVIRONMENTAL ELEMENTS
- BLENDS THE FISHERMAN'S PROFILE INTO THE SURROUNDING ENVIRONMENT
- CAN BE WORN STAND ALONE, OR OVER A WETSUIT



TECHNICAL FEATURES

Thickness	-			
Fabric type	POLYESTER			
Sizes	S	M	L	XL

UNDERSUIT

code: **422424**

- NEOPRENE WITH OUTER COVERING AND OPEN-CELL INTERIOR



TECHNICAL FEATURES

Thickness	2 mm			
Sizes	S	M	L	XL

WEIGHT POCKET BERMUDA

code Black: **422425**
code Illusion: **422491**

- NEOPRENE WITH OUTER COVERING AND OPEN-CELL INTERIOR
- TWO SIDE POCKETS DESIGNED TO HOLD 500 gr OR 1 kg STANDARD WEIGHTS



TECHNICAL FEATURES

Thickness	2 mm			
Sizes	S	M	L	XL

BACKPACK

code Black: **425861**
code Illusion: **425863**
code Camo Black: **425867**

- ANATOMICAL MODULAR BACKPACK
- POCKETS WITH HOLES FOR STANDARD 500 gr OR 1kg WEIGHTS, MAXIMUM 4kg
- ELASTIC CORD FOR FASTENING TO THE BELT
- QUICK RELEASE SYSTEM



GLOVES SMOOTH SKIN

code: **422755**

- VARIABLE THICKNESS
- PREFORMED CUT
- NEOPRENE WITH SMOOTH EXTERIOR, LINED INTERIOR
- REINFORCED PALM AND FINGERS



TECHNICAL FEATURES

Thickness	3.5 mm			
Sizes	S	M	L	XL

SOCKS SMOOTH SKIN

code: **422654**

- SMOOTH OUTSIDE / LINED INSIDE
- PREFORMED CUT
- REINFORCED DOUBLE-LINED SOLE



TECHNICAL FEATURES

Thickness	3.0 mm			
Sizes	S	M	L	XL

GLOVES FLEX

code 3 mm: **422750**
code 2 mm: **422759**

- DOUBLE LINED ULTRASTRETCH NEOPRENE
- REINFORCED PALM AND FINGERS



TECHNICAL FEATURES

Thickness	2.0 mm		
Sizes	XS/S	M/L	XL

Thickness	3.0 mm		
Sizes	XS	M	XL

SOCKS FLEX

code 5 mm: **422656**
code 3 mm: **422657**
code 2 mm: **422658**

- ULTRASTRETCH NEOPRENE
- EXTERNAL COATING / OPEN CELL INTERIOR
- REINFORCED DOUBLE-LINED SOLE



TECHNICAL FEATURES

Thickness	2.0 mm / 3.0 mm / 5.0 mm		
Sizes	XS/S	M/L	XL/XXL

GLOVES FLEX GOLD

code 5 mm: **422762**
code 3 mm: **422763**

- ULTRA STRETCH EXTERNAL FABRIC / SPECIAL GOLD TREATMENT ON OPEN CELL INSIDE
- DOUBLE LINED NEOPRENE ON PALM
- REINFORCED FABRIC ON PALM AND FINGERS



TECHNICAL FEATURES

Thickness	3.0 mm / 5.0 mm			
Sizes	S	M	L	XL

SOCKS FLEX GOLD

code 5 mm: **422661**
code 3 mm: **422660**

- ULTRA STRETCH EXTERNAL FABRIC / SPECIAL GOLD TREATMENT ON OPEN CELL INSIDE
- DOUBLE-LINED SOLE WITH EXTERNAL FABRIC REINFORCEMENT



TECHNICAL FEATURES

Thickness	3.0 mm / 5.0 mm			
Sizes	S	M	L	XL



SLING GUNS

VIPER PRO DS

120 cm - 110 cm - 100 cm - 90 cm - 75 cm

code: 423426

- RIGID ANODIZED ALUMINUM BARREL WITH UPPER SHAFT GUIDE AND LOWER LINE GUIDE
- OPEN MUZZLE CONFIGURATION, WITH OFF-AXIS HOLES
- HIGHLY SENSITIVE TRIGGER MECHANISM IN A REVERSED POSITION
- STAINLESS STEEL SIDE LINE RELEASE
- STAINLESS STEEL TRIGGER
- PREFORMED HANDLE WITH NEW HIGH-FUNCTIONALITY ANATOMIC GRIP
- VARIABLE DEFORMATION REINFORCED LOADING PAD
- 6.5 mm SINGLE BARB TAHITIAN HARDY SHAFT
- TWO 16 mm S-POWER SPEED CIRCULAR SLINGS WITH DYNEEMA® WISHBONE
- INCLUDES SPIRO VERTICAL REEL

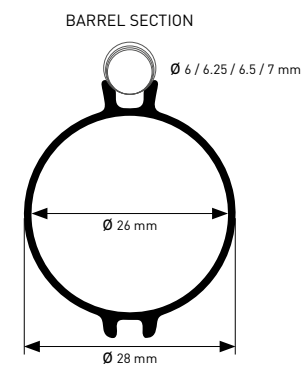

TECHNICAL FEATURES

Barrel	28 mm					
Size	75	90	100	110	120	
Shaft Hardy	Ømm	6,5	6,5	6,5	6,5	6,5
	cm	115	130	140	150	160
Two S-Power Speed circular slings	Ømm	16	16	16	16	16
	cm	42	50	55	60	65
Vertical Reel	65	65	87	87	87	

DETAILS



HANDLE VIPER PRO DS

code : 423994



VIPER PRO

110 cm - 100 cm - 90 cm - 75 cm

code: 423416

- RIGID ANODIZED ALUMINUM BARREL WITH UPPER SHAFT GUIDE AND LOWER LINE GUIDE
- OPEN MUZZLE CONFIGURATION, WITH OFF-AXIS HOLES
- HIGHLY SENSITIVE TRIGGER MECHANISM IN A REVERSED POSITION
- STAINLESS STEEL SIDE LINE RELEASE
- PREFORMED HANDLE WITH NEW HIGH-FUNCTIONALITY ANATOMIC GRIP
- VARIABLE DEFORMATION REINFORCED LOADING PAD
- SHAFT SPEED: 6,5 mm SINGLE BARB TAHITIAN SHAFT
- 17,5 mm S-POWER SPEED CIRCULAR SLING WITH DYNEEMA® WISHBONE
- INCLUDES SPIRO VERTICAL REEL

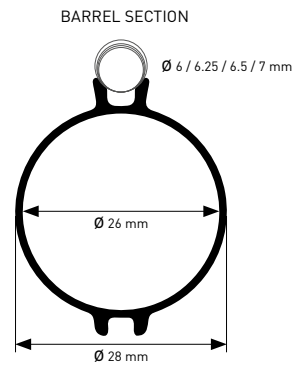

TECHNICAL FEATURES

Barrel	28 mm				
Size	75	90	100	110	
Speed Shaft	Ømm	6,5	6,5	6,5	6,5
	cm	115	130	140	150
S-Power Speed Circular Sling	Ømm	17,5	17,5	17,5	17,5
	cm	48	60	65	70
Vertical Spiro Reel	cm	65	65	87	87



SNIPER PRO

110 cm - 100 cm - 90 cm - 75 cm

code: 423425

- RIGID ANODIZED ALUMINUM BARREL WITH UPPER SHAFT GUIDE AND LOWER LINE GUIDE
- COMPACT MUZZLE WITH CIRCULAR SLING
- SHAFT RELEASE AND LINE RELEASE MADE OUT OF STAINLESS STEEL
- ERGONOMIC HANDLE MIMICS THE SHAPE USED ON THE VIPER PRO
- SET UP FOR A VERTICAL SPIRO REEL
- SHAFT GALVANIZED STEEL PR80, 6,5 mm SINGLE BARB TAHITIAN SHAFT
- S-POWER SPEED 16 mm CIRCULAR SLING WITH DYNEEMA® WISHBONE



TECHNICAL FEATURES

Barrel	28 mm				
Size	75	90	100	110	
Tahitian shaft PR80	Ømm	6,5	6,5	6,5	6,5
	cm	115	130	140	150
S-Power Speed Circular Sling	Ømm	16	16	16	16
	cm	42	50	55	60

BARREL SECTION

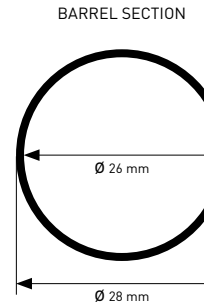
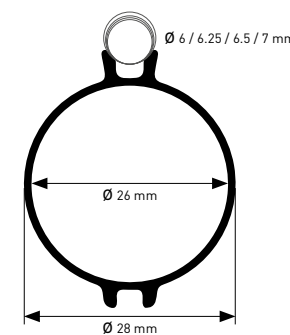

SNIPER PS

90 cm - 75 cm - 55 cm - 45 cm

code: 423424

- OUTER BARREL IN ANODIZED ALUMINUM
- NEW COMPACT MUZZLE FOR PAIR OF SLINGS
- SHAFT RELEASE AND LINE RELEASE MADE OUT OF STAINLESS STEEL
- ERGONOMIC HANDLE MIMICS THE SHAPE USED ON VIPER PRO
- SET UP FOR A VERTICAL SPIRO REEL
- SHAFT GALVANIZED STEEL PR80, 6,5 mm SINGLE BARB TAHITIAN SHAFT
- PAIR OF 16 mm S-POWER SLINGS
- RACE WISHBONE



TECHNICAL FEATURES

Barrel	28 mm				
Size	45	55	75	90	
Tahitian shaft PR80	Ømm	6,5	6,5	6,5	6,5
	cm	75	85	115	130
S-Power pair of slings	Ømm	16	16	16	16
	cm	16	19	22	24

SNIPER

90 cm - 75 cm - 55 cm - 45 cm

code: 423421

- BARREL IN ANODIZED ALUMINUM
- COMPACT MUZZLE WITH CIRCULAR SLING
- SHAFT RELEASE AND LINE RELEASE MADE OUT OF STAINLESS STEEL
- ERGONOMIC HANDLE MIMICS THE SHAPE USED ON VIPER PRO
- SET UP FOR A VERTICAL SPIRO REEL
- SHAFT GALVANIZED STEEL PR80, 6,5 mm SINGLE BARB TAHITIAN SHAFT
- 16 mm S-POWER CIRCULAR SLING
- RACE WISHBONE



SNIPER ALPHA

75 cm - 55 cm - 45 cm - 35 cm

code: 423422

- OUTER BARREL IN ANODIZED ALUMINUM
- COMPACT MUZZLE WITH CIRCULAR SLING
- SHAFT RELEASE AND LINE RELEASE MADE OUT OF STAINLESS STEEL
- ERGONOMIC HANDLE MIMICS THE SHAPE USED ON VIPER PRO
- SET UP FOR A VERTICAL SPIRO REEL
- SHAFT GALVANIZED STEEL PR80, 7 mm THREADED
- SINGLE-BARB BULLET SPEAR TIP
- 14 mm S-POWER CIRCULAR SLING
- RACE WISHBONE



Code	Viper Pro DS					Viper Pro				Sniper Pro				Sniper PS				Sniper				Sniper Alpha			
	423426					423416				423425				423424				423421				423422			
Sizes	75	90	100	110	120	75	90	100	110	75	90	100	110	45	55	75	90	45	55	75	90	35	45	55	75
Barrel	28					28				28				28				28				25			
Shaft Hardy	Ømm	6,5	6,5	6,5	6,5	6,5																			
	cm	115	130	140	150	160																			
Tahitian shaft PR80	Ømm										6,5	6,5	6,5	6,5	6,5	6,5	6,5	6,5	6,5	6,5	6,5	6,5			
	cm										115	130	140	150	75	85	115	130	75	85	115	130			
Thread shaft PR80	Ømm																					7	7	7	7
	cm																					58	68	78	98
Shaft Speed	Ømm						6,5	6,5	6,5	6,5															
	cm						115	130	140	150															
S-Power circular sling	Ømm																					16	16	16	16
	cm																					30	34	50	60
S-Power pair of slings	Ømm																								
	cm																								
S-Power Speed circular sling	Ømm						17,5	17,5	17,5	17,5	16	16	16	16											
	cm						48	60	65	70	42	50	55	60											
Two S-Power Speed circular slings	Ømm	16	16	16	16	16																			
	cm	42	50	55	60	65																			
Reel	Vertical Spiro 87			■	■	■					■	■													
	Vertical Spiro 65	■	■				■	■																	

TECHNICAL FEATURES

Barrel	28 mm				
Size	45	55	75	90	
Tahitian Shaft	Ømm	6,5	6,5	6,5	6,5
	cm	75	85	115	130
S-Power Circular Sling	Ømm	16	16	16	16
	cm	30	34	50	60

TECHNICAL FEATURES

Barrel	25 mm				
Size	35	45	55	75	
Thread Shaft	Ømm	7	7	7	7
	cm	58	68	78	98
S-Power Circular Sling	Ømm	14	14	14	14
	cm	28	30	34	50

BARREL SECTION

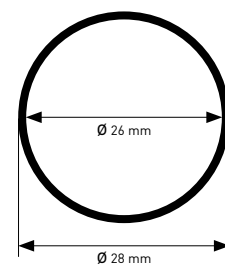

BARREL SECTION

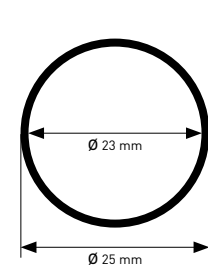

The measurements shown in the table refer to the standard sling gun equipment.



HYDRO TORPEDO LARGE

code: 425717

- LARGE BUOY WITH RUGGED OUTER COVER
- 500D ORANGE PVC OFFERING GREAT RESISTANCE, VISIBILITY AND A SMOOTH SURFACE FOR EASE OF MOVEMENT
- S.S. D-RING WITH DRAG POINT OPTIMIZED TO INCREASE GLIDE OVER THE WATER
- 6 NYLON D-RINGS
- 20 METERS OF FLOAT LINE + NYLON SNAP INCLUDED
- 30.5 X 30.5 cm DIVE FLAG



HYDRO TORPEDO

code: 425718

- BUOY WITH A RUGGED OUTER COVER
- 500D ORANGE PVC OFFERING GREAT RESISTANCE, VISIBILITY AND A SMOOTH SURFACE FOR EASE OF MOVEMENT
- 20 METERS OF FLOAT LINE + NYLON SNAP INCLUDED
- NYLON D-RINGS AND 18.5 X 18.5 cm DIVE FLAG



HYDRO FLAT

code: 425720

- FLAT BUOY WITH RUGGED OUTER COVER
- 500D ORANGE PVC OFFERING GREAT RESISTANCE, VISIBILITY AND A SMOOTH SURFACE FOR EASE OF MOVEMENT
- 7 NYLON D-RINGS
- 20 METERS OF FLOAT LINE + NYLON SNAP INCLUDED
- 30.5 X 30.5 cm DIVE FLAG



HYDRO SPHERE

code: 425719

- BUOY WITH A RUGGED OUTER COVER
- 500D ORANGE PVC OFFERING GREAT RESISTANCE, VISIBILITY AND A SMOOTH SURFACE FOR EASE OF MOVEMENT
- 20 METERS OF FLOAT LINE + NYLON SNAP INCLUDED
- NYLON D-RINGS AND 18.5 X 18.5 cm DIVE FLAG



HOLDER

code: 425716

- CAN BE MOUNTED ON 425717, 425720 AND 425715
- ONLY FOR USE WITH FLAG CODE 45200301



DIVE FLAG 30,5 x 30,5 cm

code: 45200301

- FLAG SIZE: 30.5 X 30.5 cm
- CAN BE MOUNTED ON 425717, 425720 AND 425715



DIVE FLAG 18,5 x 18,5 cm **NEW**

code: 45200412

- FLAG SIZE: 18.5 X 18.5 cm
- CAN BE MOUNTED ON 425718 AND 425719



ACCESSORIES

TORPEDO

code: 425713

- BUOYS MADE OF RESILIENT PVC
- FASTENING RINGS ON THE BOTTOM
- INCLUDES 20 METERS OF LINE AND CARABINER



APNEA

code: 425711

- BUOY MADE OF RESILIENT PVC
- FEATURES A PEAK WITH RING
- DRAG POINT OPTIMIZED TO INCREASE GLIDE OVER THE WATER



SPHERE

code: 425714

- BUOYS MADE OF RESILIENT PVC
- FASTENING RINGS ON THE BOTTOM
- INCLUDES 20 METERS OF LINE AND CARABINER



LINE HOLDER

code: 423946



EOS ALPHA

code: 425663

- SINGLE 1-WATT LED
- REFLECTOR - POLYCARBONATE (HOT SPOT)
- SLIDING MAGNETIC SWITCH WITH CONTINUOUS-ON OR OFF POSITION
- POWERED BY 4 1.5V AA BATTERIES (NOT INCLUDED)
- 900 MINUTES OF CONTINUOUS BURN TIME, 2100 MINUTES WITH INTERMITTENT 60 SECOND ON/OFF
- WATERPROOF DOWN TO 50 m/165 ft



TECHNICAL FEATURES

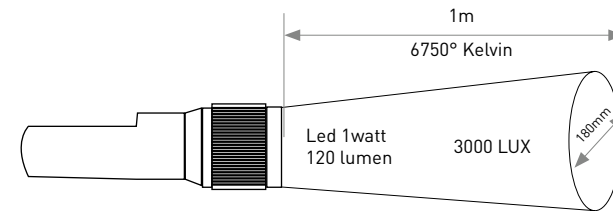

Max depth	50 m/164ft
Switch	Magnetic switch [continuous-on or off position]
Batteries (not included)	4AA Alkaline 4AA Rechargeable(2700 mAh)
Continuous burn time	Over 900 minutes
Burn time with intermittent 60 sec. On / 60 sec. Off	Over 2100 minutes
Reflector	Polycarbonate (Hot Spot)
Front lens	Polycarbonate, 3mm thick
Head	Polycarbonate
Strap	Lanyard
Dimensions	
Maximum diameter (head)	43mm
Diameter of tubular grip (body)	25mm
Length	153mm
Bulb	Mono LED 1W/120 lumens
Bright spot (at 1meter distance)	3000 lux
Color temperature	6750 °K

HANDLE GRIP "KJ"

code: 423973

- PREFORMED GRIP
- BETTER MANAGEABILITY AND EXCELLENT STABILITY
- DESIGN FACILITATES EASIER AIMING
- CAN BE USED ON THE CYRANO 1.1 HFT, CYRANO 1.1, CYRANO 1.3, VIPER PRO AND VIPER PRO DS



HP GAUGE

code: 423947

- HP GAUGE FOR MARES PNEUMATIC GUNS
- WHEN YOU ATTACH THIS ACCESSORY ON THE INLET VALVE, THE GAUGE SHOWS THE PRESSURE OF THE GUN



LOADER CLEVER

code: 423941

- MULTI-FUNCTIONAL LOADER FOR SHAFTS FITTED WITH SPEAR TIPS OR MULTIPRONGS
- LOADER ALSO FEATURES TABS FOR UNSCREWING A PNEUMATIC GUN VALVE COVER CAP



LINE SLIDER RACE

code: 423937 for 8mm shaft

code: 423938 for 7mm shaft

- COMPACT HYDRODYNAMIC LINE SLIDER
- FOR PNEUMATIC GUNS WITH A 7 mm / 8 mm SHAFT
- PACK OF 5PCS



POWER LOADER

code: 413807

- POWER LOADER FOR MARES PNEUMATIC GUNS
- DEDICATED TO SERVICE CENTERS



INJECTOR

code: 423901

- MANUAL AIR INJECTOR FOR MARES PNEUMATIC GUNS



LONG LOADER CLEVER

code: 423942

- LONG VERSION OF THE CLEVER LOADER
- IT ALLOWS THE USER TO LOAD PNEUMATIC GUNS SAFELY AND EASILY



SLING PROTECTION

code: 423939

- INTENDED FOR USE ON SLING GUNS WHEN NOT IN USE
- HELPS SAFEGUARD AGAINST PREMATURE AGING OF THE SLINGS DUE TO EXPOSURE TO THE SUN



MULTIPRONGS MARES PRO



code: 423724 - 3P/4P/5P

- HIGHLY HYDRODYNAMIC SHAPE
- GREAT SPEED AND STABILITY, EVEN ON LONGER SHOTS
- THE SPECIAL PRONG ANGLE MEANS GREATER HOLDING POWER TO RESTRAIN PREY
- BLACK PLASTIC BASE WITH RESISTANT TECHNOPYLIMER
- MUSTAD® PRONGS
- THREAD M7
- PACK OF 10PCS
(RETAIL PRICE FOR 1 PIECE)



MULTIPRONGS MARES



code: 423725 - 3P/4P/5P

- HIGHLY HYDRODYNAMIC SHAPE
- GREAT SPEED AND STABILITY, EVEN ON LONGER SHOTS
- SPECIAL PRONG ANGLE
- THE ANGLED PRONGS MEAN GREATER HOLDING POWER TO RESTRAIN PREY
- WHITE PLASTIC BASE WITH RESISTANT TECHNOPYLIMER
- MUSTAD® PRONGS
- THREAD M7
- PACK OF 10PCS
(RETAIL PRICE FOR 1 PIECE)



INOX MULTIPRONGS

code: 423719

code: 423720

- STAINLESS STEEL
- BLACK NYLON BASE
- THREAD M7
- STAINLESS STEEL
- BLACK NYLON BASE
- THREAD M7



MULTIPRONGS MARES PROTECTOR

code: 45200320

- PROTECTION FOR THREE, FOUR AND FIVE PRONGED MARES MULTIPRONGS
- PACK OF 10PCS
(RETAIL PRICE FOR 1 PIECE)



BULLET 1 BARB

code: 423726

- GALVANIZED STEEL PR80
- 10 PCS (RETAIL PRICE FOR 1 PIECE)
- THREAD M7



BULLET 2 BARB

code: 423727

- GALVANIZED STEEL PR80
- 10 PCS (RETAIL PRICE FOR 1 PIECE)
- THREAD M7



BULLET PRO

code: 423728

- TEMPERED STAINLESS STEEL
- 10 PCS (RETAIL PRICE FOR 1 PIECE)
- THREAD M7



BULLET MINI

code: 423729

- STAINLESS STEEL
- 10 PCS (RETAIL PRICE FOR 1 PIECE)
- THREAD M7



SHAFTS FOR PNEUMATIC GUNS

Shaft PNGun RACE 17-4PH d8 tah1barb

code: 423265



Shaft PNGun RACE 17-4PH d7 tah1barb

code: 423257



DIAMETER	LENGTH	MODELS
Ø 8 mm	97 cm	Cyrano 1.3
	107 cm	Cyrano 1.3
	122 cm	Cyrano 1.3
	132 cm	Cyrano 1.3

DIAMETER	LENGTH	MODELS
Ø 7 mm	97 cm	Cyrano 1.1 HFT - Cyrano 1.1
	107 cm	Cyrano 1.1 HFT - Cyrano 1.1
	122 cm	Cyrano 1.1 HFT - Cyrano 1.1
	132 cm	Cyrano 1.1 HFT - Cyrano 1.1

SHAFTS FOR PNEUMATIC GUNS

Shaft PNGun GS PR80 d8 thread

code: 423259



DIAMETER	LENGTH	TYPE	MODELS
Ø 8 mm	36,9 cm	Thread M7	Sten - Jet - Cyrano 1.3
	51,9 cm		Sten - Jet - Cyrano 1.3
	66,9 cm		Sten - Jet - Cyrano 1.3
	86,9 cm		Sten
	98,4 cm		Sten

Shaft PNGun GS PR80 d7 thread

code: 423258



DIAMETER	LENGTH	TYPE	MODELS
Ø 7 mm	35,9 cm	Thread M7	Cyrano 1.1
	56,9 cm		Cyrano 1.1 - Sten 11
	67,1 cm		Cyrano 1.1 - Sten 11
	86,5 cm		
	96,5 cm		
	106,5 cm		

Shaft PNGun SS d8 thread

code: 423260



DIAMETER	LENGTH	TYPE	MODELS
Ø 8 mm	36,9 cm	Thread M7	
	51,9 cm		
	66,9 cm		
	86,9 cm		
	98,4 cm		

TIP PROTECTION

code: 43200496

■ ONLY FOR MARES SHAFTS



LEGEND

SLGun	Sling Gun
PNGun	Pneumatic Gun
17-4PH	Steel 17-PH
GS PR80	Galvanized Steel PR80
SS	Stainles Steel
d	diameter
tah	tahitian
TR	tricuspid

SHAFTS FOR SLING GUNS

Shaft SLGun HARDY TR 17-4PH d6.5 tah1barb

code: 423266



DIAMETER	LENGTH	MODELS
Ø 6,5 mm	115 cm	
	130 cm	
	140 cm	
	150 cm	
	160 cm	

Shaft SLGun HARDY TR 17-4PH d7 tah1barb

code: 423264



DIAMETER	LENGTH	MODELS
Ø 7 mm	115 cm	
	130 cm	
	140 cm	
	150 cm	
	160 cm	

Shaft SLGun HARDY 17-4PH d6.5 tah1barb

code: 423254



DIAMETER	LENGTH	MODELS
Ø 6,5 mm	115 cm	Viper Pro DS
	130 cm	Viper Pro DS
	140 cm	Viper Pro DS
	150 cm	Viper Pro DS
	160 cm	Viper Pro DS

Shaft SLGun 17-4PH d6.5 tah1barb

code: 423226



DIAMETER	LENGTH	MODELS
Ø 6,5 mm	85 cm	
	115 cm	
	130 cm	
	140 cm	
	150 cm	
160 cm		

SHAFTS FOR SLING GUNS

Shaft SLGun 17-4PH d6.25 tah1barb

code: 423263



DIAMETER	LENGTH
Ø 6,25 mm	85 cm
	115 cm
	130 cm
	140 cm
	150 cm

Shaft SLGun 17-4PH d6 tah1barb

code: 423262



DIAMETER	LENGTH
Ø 6 mm	85 cm
	115 cm
	130 cm
	140 cm
	150 cm

Shaft SLGun GS PR80 d6.5 tah1barb

code: 423256



DIAMETER	LENGTH	MODELS
Ø 6,5 mm	75 cm	Sniper - Sniper PS
	85 cm	Sniper - Sniper PS
	115 cm	Sniper - Sniper Pro - Sniper PS
	130 cm	Sniper - Sniper Pro - Sniper PS
	140 cm	Sniper Pro
	150 cm	Sniper Pro

Shaft SLGun GS PR80 d7 thread

code: 423255



DIAMETER	LENGTH	MODELS
Ø 7 mm	58 cm	Sniper Alpha
	68 cm	Sniper Alpha
	78 cm	Sniper Alpha
	98 cm	Sniper Alpha
	113 cm	Sniper Alpha

VERTICAL SPIRO 65

code: 423933

- 65 mm SPOOL
- DESIGNED SPECIFICALLY FOR MARES SPEARGUNS
- THE PIN ON THE REEL HELPS THE LINE PASS SNUGLY ALONG THE OUTER BARREL
- MARES PATENTED CLUTCH



TECHNICAL FEATURES

Cyrano 1.1 HFT - Cyrano 1.1 - Cyrano 1.3 - Viper Pro - Viper Pro DS - Sniper - Sniper Pro - Sniper PS - Sniper Alpha				
423804 Camo line Ø 1,6mm - 80kg	423803 Black line Ø 1,65mm - 100kg	423922 Diamond line Ø 1mm - 130kg	423921 Diamond line Ø 1,5mm - 180kg	423920 Diamond line Ø 2mm - 300kg
30 m	30 m	55 m	35 m	20 m

VERTICAL SPIRO 87

code: 423934

- 87 mm SPOOL
- DESIGNED SPECIFICALLY FOR MARES SPEARGUNS
- THE LINE GUIDE ON THE REEL HELPS THE LINE PASS SNUGLY ALONG THE OUTER BARREL
- MARES PATENTED CLUTCH



TECHNICAL FEATURES

Cyrano 1.1 HFT - Cyrano 1.1 - Cyrano 1.3 - Viper Pro - Viper Pro DS - Sniper - Sniper Pro - Sniper PS - Sniper Alpha				
423804 Camo line Ø 1,6mm - 80kg	423803 Black line Ø 1,65mm - 100kg	423922 Diamond line Ø 1mm - 130kg	423921 Diamond line Ø 1,5mm - 180kg	423920 Diamond line Ø 2mm - 300kg
60 m	60 m	85 m	65 m	40 m

REEL

code: 423856

- 85 mm SPOOL
- DEDICATED TO STEN - STEN 11 - JET



LATEX S-POWER BROWN ROLL

- TWO MATERIALS MARES S-POWER LATEX
- THIN BROWN UV PROTECTION OUTSIDE AND AMBER NATURAL LATEX INSIDE
- PROGRESSIVE LATEX AND CONSTANT POWER OVER LONG TERM
- 5 METER ROLL

code: 423989

DIAMETER	LENGTH
Ø 14 mm	5 meter roll

code: 423990

DIAMETER	LENGTH
Ø 16,5 mm	5 meter roll

code: 423991

DIAMETER	LENGTH
Ø 18 mm	5 meter roll

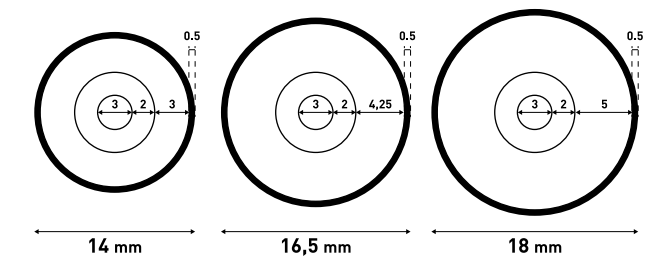

S-POWER SLINGS PAIR

- MARES S-POWER LATEX
- CONICAL RING PREVENTS THE PARACHUTE EFFECT AND INCREASES THE SPEED



code: **423957**

DIAMETER	LENGTH
Ø 16 mm	16 cm
	19 cm
	22 cm
	24 cm
	26 cm

code: **423962**

DIAMETER	LENGTH
Ø 19 mm	19 cm
	22 cm
	24 cm
	26 cm
	28 cm

code: **423958**

DIAMETER	LENGTH
Ø 17,5 mm	16 cm
	19 cm
	22 cm
	24 cm
	26 cm
	28 cm

S-POWER SLINGS CIRCULAR

- MARES S-POWER LATEX
- CONICAL RING PREVENTS THE PARACHUTE EFFECT AND INCREASES THE SPEED

code: **423970**

DIAMETER	LENGTH
Ø 14 mm	28 cm
	30 cm
	34 cm
	50 cm

code: **423963**

DIAMETER	LENGTH
Ø 16 mm	30 cm
	34 cm
	42 cm
	44 cm
	50 cm
	60 cm

code: **423959**

DIAMETER	LENGTH
Ø 17,5 mm	34 cm
	42 cm
	48 cm
	55 cm
	60 cm
	65 cm

code: **423964**

DIAMETER	LENGTH
Ø 19 mm	48 cm
	60 cm
	65 cm
	70 cm

S-POWER SLINGS SPEED CIRCULAR

- MARES S-POWER LATEX
- INTERCHANGEABLE WISHBONE IN 2 mm DYNEEMA®
- DESIGNED FOR SHAFTS WITH SPECIALLY POLISHED NOTCHES, PINS OR SHARK FINS
- NO PARACHUTE EFFECT, INCREASES SPEED



code: **423966**

DIAMETER	LENGTH
Ø 16 mm	42 cm
	50 cm
	55 cm
	60 cm
	65 cm

code: **423960**

DIAMETER	LENGTH
Ø 17,5 mm	42 cm
	48 cm
	55 cm
	60 cm
	65 cm
	70 cm

code: **423965**

DIAMETER	LENGTH
Ø 19 mm	48 cm
	60 cm
	65 cm
	70 cm

S-POWER SLINGS SPEED CIRCULAR NEW

- TWO-MATERIAL MARES S-POWER LATEX
- THIN, BROWN LATEX UV PROTECTION OUTSIDE AND AMBER, NATURAL LATEX INSIDE
- PROGRESSIVE LATEX SLING OFFERING CONSTANT POWER OVER THE LONG TERM
- INTERCHANGEABLE WISHBONE IN 2 MM DYNEEMA®
- DESIGNED FOR SHAFTS WITH SPECIALLY POLISHED NOTCHES, PINS OR SHARK FINS
- NO PARACHUTE EFFECT, INCREASES SPEED



code: **423870**

DIAMETER	LENGTH
Ø 14 mm	42 cm
	48 cm
	55 cm
	60 cm
	65 cm
	70 cm

code: **423871**

DIAMETER	LENGTH
Ø 16,5 mm	42 cm
	48 cm
	55 cm
	60 cm
	65 cm
	70 cm

code: **423872**

DIAMETER	LENGTH
Ø 18 mm	42 cm
	48 cm
	55 cm
	60 cm
	65 cm
	70 cm

ARTICULATED BIND WISHBONE

code: 423915



ARTICULATED WISHBONE

code: 423914



LARIO BIND WISHBONE

code: 423913



LARIO WISHBONE

code: 423912



RACE WISHBONE

code: 423967



LOADER WISHBONE KIT

code: 423904



SPEED

code: 423911

- CONNECTOR END MADE OF SPECIAL 2 mm DYNEEMA® LINE
- DESIGNED FOR SHAFTS WITH SPECIALLY POLISHED NOTCHES, PINS OR SHARK FINS
- NO PARACHUTE EFFECT, INCREASES SPEED



SPEED2

code: 423916

- CONNECTOR END MADE OF SPECIAL 2 mm DYNEEMA® LINE
- DESIGNED FOR SHAFTS WITH SPECIALLY POLISHED NOTCHES, PINS OR SHARK FINS
- NO PARACHUTE EFFECT, INCREASES SPEED



SPEED3

code: 423936

- CONNECTOR END MADE OF SPECIAL 2 mm DYNEEMA® LINE
- DESIGNED FOR SHAFTS WITH SPECIALLY POLISHED NOTCHES, PINS OR SHARK FINS
- NO PARACHUTE EFFECT, INCREASES SPEED

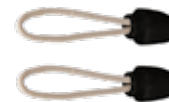

WISHBONE TOOL

code: 423940



PAIR OF SLINGS SUPPORT

code: 423944



LINE DYNEEMA

code: 423993

- SPECIAL 2mm DYNEEMA , THE BEST MATERIAL FOR WISHBONES
- 10 METERS





DIAMOND LINE

DIAMOND LINE 1 mm

code: 423922



TECHNICAL FEATURES



Materials	100% Dyneema core HT Polyester covering  
Diameter	1 mm
Resistance	120 kg
Length of roll	100 meters

DIAMOND LINE 1,5 mm

code: 423921



TECHNICAL FEATURES



Materials	100% Dyneema core HT Polyester covering  
Diameter	1,5 mm
Resistance	180 kg
Length of roll	100 meters

DIAMOND LINE 2 mm

code: 423920



TECHNICAL FEATURES

Materials	100% Dyneema core HT Polyester covering  
Diameter	2 mm
Resistance	300 kg
Length of roll	50 meters

CAMO LINE

code: 423804



TECHNICAL FEATURES

Materials	HT Polyester covering 
Diameter	1,65 mm
Resistance	100 kg
Length of roll	100 meters

BLACK LINE

code: 423803



TECHNICAL FEATURES

Materials	HT Polyester covering 
Diameter	1,6 mm
Resistance	80 kg
Length of roll	50 meters

BLACK MONOLINE

code: 423931



TECHNICAL FEATURES

Materials	Nylon
Diameter	1,5 mm
Resistance	80 kg
Length of roll	25 meters

ARGO

code: 425615

- COMPACT KNIFE WITH ERGONOMIC HANDLE
- 3 mm STAINLESS STEEL BLADE, LENGTH 72 mm
- MICRO SERRATION TO GUARANTEE EXCELLENT CUTTING POWER
- THE QUICK-RELEASE SYSTEM MEANS YOU CAN USE IT QUICKLY
- CAN BE STRAPPED ON THE ARM, CALF OR BELT
- TWO ADJUSTABLE ELASTIC VELCRO STRAPS

**ARGO TITANIUM**

code: 425616

- COMPACT KNIFE WITH ERGONOMIC HANDLE
- 3 mm TITANIUM BLADE, LENGTH 72 mm
- MICRO-SERRATION TO GUARANTEE EXCELLENT CUTTING POWER
- THE QUICK-RELEASE SYSTEM MEANS YOU CAN USE IT QUICKLY
- CAN BE STRAPPED ON THE ARM, CALF OR BELT
- TWO ADJUSTABLE ELASTIC VELCRO STRAPS

**DAGGER**

code: 425610

- KNIFE WITH ERGONOMIC HANDLE
- 4 mm 420A STAINLESS STEEL BLADE, PVD-TREATED
- LENGTH OF BLADE: 98 mm
- MICRO-SERRATION TO GUARANTEE EXCELLENT CUTTING POWER
- THE QUICK-RELEASE SYSTEM MEANS YOU CAN USE IT QUICKLY
- CAN BE STRAPPED ON THE ARM, CALF OR BELT
- TWO STRAPS AND QUICK RELEASE BUCKLES

**STILETTO**

code: 425611

- COMPACT KNIFE WITH ERGONOMIC HANDLE
- 4 mm 420A STAINLESS STEEL BLADE, PVD-TREATED
- LENGTH OF BLADE: 65 mm
- MICRO-SERRATION TO GUARANTEE EXCELLENT CUTTING POWER
- THE QUICK-RELEASE SYSTEM MEANS YOU CAN USE IT QUICKLY
- CAN BE STRAPPED ON THE ARM, CALF OR BELT
- TWO STRAPS WITH QUICK RELEASE BUCKLES

**IAGO**

code: 425614

- KNIFE WITH ERGONOMIC HANDLE
- 4 mm 420A STAINLESS STEEL BLADE, PVD-TREATED
- LENGTH OF BLADE: 98 mm
- MICRO-SERRATION ALONG THE ENTIRE BLADE, EXCELLENT CUTTING POWER
- BLADE WITH HOLE FOR FREEING SHAFTS STUCK IN THE ROCKS
- THE QUICK-RELEASE SYSTEM MEANS YOU CAN USE IT QUICKLY
- CAN BE STRAPPED ON THE ARM, CALF OR BELT
- TWO STRAPS, QUICK-RELEASE BUCKLES

**HERO**

code: 425613

- ULTRA-COMPACT KNIFE, TOTAL LENGTH 135 mm
- 4 mm 420A STAINLESS STEEL BLADE, PVD-TREATED
- LENGTH OF BLADE: 60 mm
- ONE CUTTING EDGE AND ONE MICRO-SERRATED SHEARING EDGE
- ERGONOMIC HANDLE WITH HOLE FOR FREEING SHAFTS STUCK IN THE ROCKS
- STURDY CORDURA SHEATH
- CAN BE STRAPPED ON THE ARM, CALF OR BELT
- TWO ADJUSTABLE ELASTIC VELCRO STRAPS

**SNAKE**

code: 425612

- STAINLESS STEEL BLADE
- LENGTH OF BLADE 135 mm
- ONE CUTTING EDGE AND ONE MICRO-SERRATED SHEARING EDGE
- SOFT, ANTI-SLIP HANDLE
- SEMI-RIGID SCABBARD THAT CAN BE FASTENED ON THE LEG OR BELT
- TWO STRAPS, QUICK-RELEASE BUCKLES

**QUICK-RELEASE WEIGHT**

code: 425860

- 1 KG QUICK-RELEASE WEIGHT, FAST AND EASY TO USE
- IDEAL FOR BUOYANCY CHANGES
- EXCLUSIVE MARES PATENT

**BELT ELASTIC W/NYLON BUCKLE**

code: 425812 WH

code: 425812 BK

- QUICK-RELEASE NYLON BUCKLE
- 3 mm ELASTIC TAPE, 140 cm LONG

**BELT ELASTIC W/MARSEILLAISE S.S.**

code: 425813 WH

code: 425813 BK

- NEW STAINLESS STEEL, QUICK-RELEASE BUCKLE
- 3 mm ELASTIC TAPE, 140 cm LONG

**FAST D-RING**

code: 425811

- 4 pcs

**SNAP HOOK**

code: 423945

- 2 pcs



FISH STRINGER

code: 423823

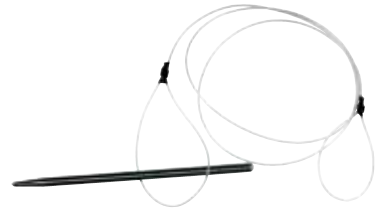
**FISH STRINGER KIT**

code: 423929

**BUNGEE WITH BIG CARABINER**

code: 423935

■ L

**BUNGEE**

code: 423923

■ M-L

**CAMERA BRACKET**

code: 423948

- ATTACHMENT POINT FOR VIDEO & CAMERA GEAR
- MOUNTS TO MARES GUNS THAT HAVE VERTICAL SPIRO REELS

**CAMERA BRACKET FOR PNEUMATIC GUNS**

code: 423971

- FOR Ø 40 mm O.D. BARRELS

**CONNECTING KNOB**

code: 423949

- THREAD UNC 1/4"

**SAFETY WHISTLE**

code: 423930

**BARB KEEPER O-RING**

code: 423926

**SLEEVES KIT**

code: 423924

- 20 PCS - FOR MONOLINE 1,4 / 1,6 mm

code: 423925

- 20 PCS - FOR MONOLINE 1,2 / 1,4 mm

**DRY BOX**

code: 415727

**SLEEVES PLIER**

code: 423968

**SHARK CLIP WITH SWIVEL**

code: 423969

**ANTIFOG**

code: 415101

- 60 ml

**GLUE FOR NEOPRENE**

code: 415108

- 20 ml

**SILICONE GREASE**

code: 415102

- 20 ml



ATTACK 100

code: 425560

- HEAT SEALED BAG WITH NO STITCHING
- ADJUSTABLE HANDLES
- ACCOMODATES LONG FREE DIVING FINS



TECHNICAL FEATURES

Dimensions (LxWxH)	Unit Net Weight	Volume
100x40x30 cm	1,6 kg	120 L

ATTACK TITAN

code: 425550

- SPACIOUS 840 DENIER TARPAULIN BAG THAT CAN CARRY 100 kg
- HEAT SEALED BAG WITH NO STITCHING
- ADJUSTABLE HANDLES ARE ATTACHED BY SNAP HOOKS TO WELDED BASE PLATES
- SIDE DRAIN VALVE



TECHNICAL FEATURES

Dimensions (LxWxH)	Unit Net Weight	Volume
90x46x35 cm	1,95 kg	144 L

ATTACK TARGET

code: 425561

- SPEARGUN CARRYING BAG
- EXTENDED OPENING ALLOWS FOR EASIER ACCESS TO THE SPEARGUN
- HANDLE AND SHOULDER STRAP FOR TRANSPORT
- TWO SIZES AVAILABLE: M-L



TECHNICAL FEATURES

Size M - Dimensions (LxWxH)	Unit Net Weight	Volume
135x4x18 cm	0,6 kg	10 L

Size L - Dimensions (LxWxH)	Unit Net Weight	Volume
155x4x18 cm	0,7 kg	12 L

ATTACK GUN

code: 425553

- SPEARGUN CARRYING BAG
- 840 DENIER TARPAULIN AND PADDED BOTTOM WITH DRAIN VALVE
- LONG OPENING TO MAKE IT EASIER TO ACCESS THE SPEARGUNS
- HANDLE AND TWO STRAPS FOR TRANSPORT



TECHNICAL FEATURES

Dimensions (LxWxH)	Unit Net Weight	Volume
175x20x20 cm	1,1 kg	70 L

ATTACK BACKPACK

code: 425558

- SPACIOUS WATERPROOF BACKPACK MADE FROM 500 DENIER TARPAULIN
- ADJUSTABLE ERGONOMIC SHOULDER STRAPS
- EXTERNAL DOCUMENT POUCH
- TWO SIDE POCKETS LET YOU CARRY LONG FINS OR MID-SIZED SPEARGUNS



TECHNICAL FEATURES

Dimensions (LxWxH)	Unit Net Weight	Volume
32x32x95 cm	1,65 kg	75 L

ATTACK DRY BAG

code: 425557

- HANDY DRY BAG WITH SHOULDER STRAP
- IDEAL FOR HOLDING WET EQUIPMENT OR CLOTHING YOU WANT TO PROTECT FROM THE WATER



TECHNICAL FEATURES

Dimensions (LxWxH)	Unit Net Weight	Volume
75x58 cm	0,5 kg	40 L

ATTACK LONG FINS

code: 425562

- THE LENGTH OF THE BAG IS SUITABLE FOR NEW, LONGER FINS
- EXTERNAL DOCUMENT POUCH
- CAN CARRY YOUR GEAR FOR SNORKELING OR TRAINING IN THE POOL
- ADJUSTABLE SHOULDER STRAP



TECHNICAL FEATURES

Dimensions (LxWxH)	Unit Net Weight	Volume
23,5x18,5x100 cm	0,7 kg	43,4 L

ATTACK MESH

code: 425554 Attack Mesh 700

code: 425555 Attack Mesh 450

- STURDY WOVEN MESH BAG
- STRAP CLOSURE



TECHNICAL FEATURES

Dimensions (LxWxH) - ATTACK MESH 700
70x45 cm

Dimensions (LxWxH) - ATTACK MESH 450
40x35 cm

SANDWICH CAP

code: 449227

- 100% COTTON
- 1 PACK = 12 PCS



FISHERMAN'S CAP

code: 449228

- 100% ACRYLIC
- 1 PACK = 12 PCS



T SHIRT TEAM

code: 449231

- 100% PRINTED COTTON
- SIZES: S/M/L/XL/XXL



FREEDIVING STICKER

code: 449939



STICKER LOGO

code: 449233

- SIZE: 70X25 cm



PEN FLAG

code: 449221

- HEIGHT 1,80 m
- 100% NYLON



KEY HOLDER RAZOR

code: 449229



LANYARD

code: 429452



		MAN						
		USA	1	2	3	4	5	6
SIZES - MEASUREMENTS		EU	XS	S	M	L	XL	XXL
		IT	1	2	3	4	5	6
A	CHEST	inch	34-36	35-38	37-40	39-41	41-43	42-45
		cm	88/92	91 / 97	95 / 101	99 / 105	103 / 109	107 / 115
B	WAIST	inch	28-29	30-33	33-35	34-37	36-38	37-41
		cm	72/76	77 / 83	83 / 89	87 / 93	91 / 97	95 / 103
C	HIPS	inch	33-35	35-38	37-39	39-41	40-43	42-45
		cm	86/90	90 / 96	94 / 100	98 / 104	102 / 108	106 / 114
D	ARM	inch	19-20	20-21	21-22	22-23	23-24	24-25
		cm	50/52	52/55	54/57	56/59	58/61	60/63
E	INSEAM	inch	25-27	27-28	28-29	29-30	30-31	31-32
		cm	66/69	68/71	70/73	72/75	74/77	76/79
F	HEIGHT	inch	62-64	65-68	67-70	69-71	71-72	72-74
		cm	160/164	166/172	170/176	174/180	178/184	182/188

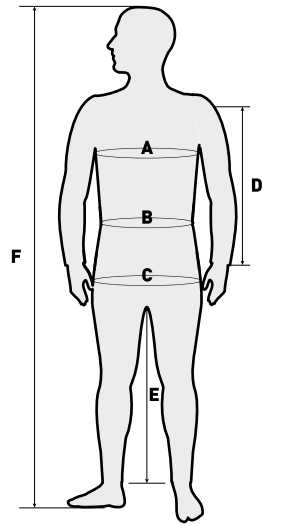

		LADY						
		USA	0	1	2	3	4	5
SIZES - MEASUREMENTS		EU	XXS	XS	S	M	L	XL
		IT	0	1	2	3	4	5
A	CHEST	inch	30-31	33-35	34-37	36-38	37-40	39-41
		cm	77/81	83-89	87-93	91-97	95-101	99-105
B	WAIST	inch	23-24	26-28	27-30	29-31	30-33	32-34
		cm	59/63	65-71	69-75	73-79	77-83	81-87
C	HIPS	inch	31-33	34-37	36-38	38-40	39-41	41-43
		cm	80/85	87-93	91-97	95-101	99-105	103-109
D	ARM	inch	18-19	19-20	20-21	21-22	22-23	23-24
		cm	47/49	48-51	50-53	52-55	54-57	56-59
E	INSEAM	inch	24-25	25-26	26-27	27-28	28-29	29-30
		cm	62/64	64-67	66-69	68-71	70-73	72-75
F	HEIGHT	inch	61-62	61-64	63-66	65-67	66-69	68-70
		cm	156/158	156-162	160-166	164-170	168-174	172-178

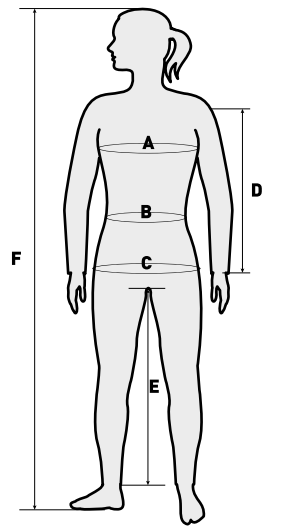

PLEASE NOTE: Freediving/Spearfishing wetsuits must fit well. Given the material used to manufacture them, the table is for reference only. We suggest trying the wetsuit at a Mares retailer.

SEMINARS 2019



THE MARES LAB SERVICE TECHNICIAN TRAINING PROGRAM

Mares Service Technician Training Courses are available throughout the world and are designed and developed based on proven effective instructional system design principals. They are the dive industry's first and only competency based service technician training courses offered worldwide that are produced and conducted by a major dive equipment manufacturer. This means you'll receive the same high quality and educationally valid training regardless of where in the world you participate in a Mares Service Technician Training Course.

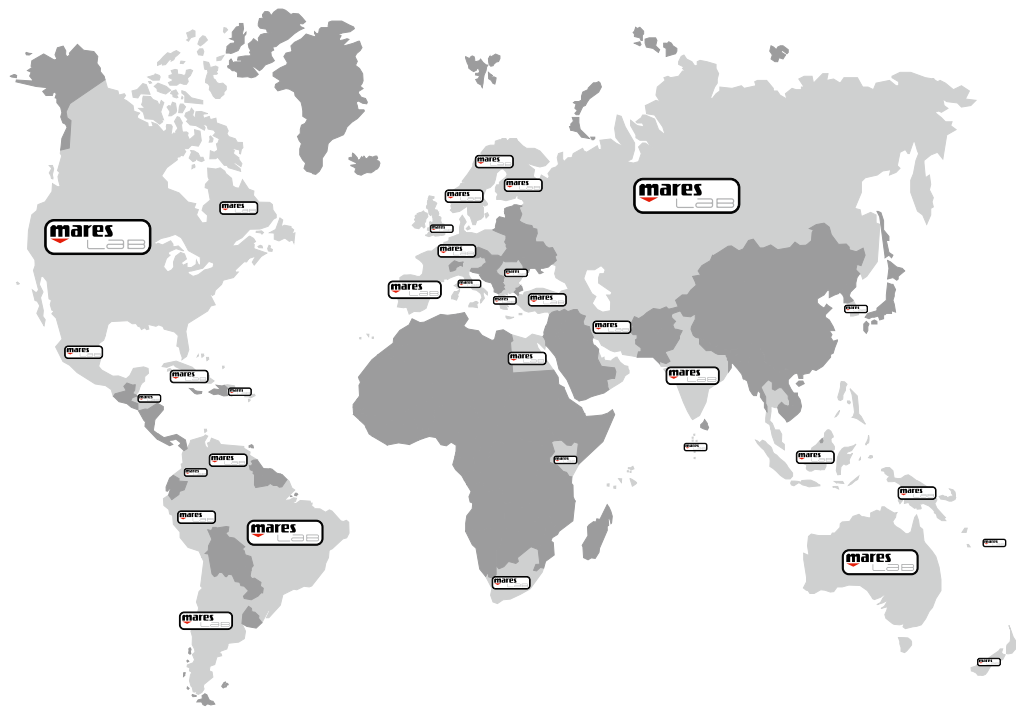

BASIC SERVICE TECHNICIAN DIGITAL LEARNING COURSE

This highly interactive online digital learning course is delivered to the learner using the latest Educational Management System (EMS) technology. The EMS platform technology along with extensive use of video and graphic content enhances learning and retention of information and produces a highly enjoyable educational experience. The course is open to anyone, and can be accessed by contacting the local Mares Subsidiary or Distributor. Take this course as the first step to becoming a fully qualified Mares Service Technician, or if you simply want to learn the basics of regulator design and service and/or repair. This course is a prerequisite requirement for most Mares Lab Skill Based Training Courses. Completion of this course does not qualify you to service or repair Mares equipment.



The course goals are to:

1. Establish your basic knowledge level relating to regulator service and repair procedures.
2. Provide you with basic information about regulator design and function.
3. Provide you with Mares specific information relating to service and repair procedures, manufacturing processes and product information.
4. Help prepare you for success in one or more Mares Lab Skill Based Training Courses.

Prerequisite Requirements:
Course is open to anyone.

MARES LAB SKILL BASED TRAINING COURSES

- MARES SERVICE TECHNICIAN
- MARES DIVING CENTER SERVICE TECHNICIAN
- MARES SPECIALTY SERVICE TECHNICIAN



After successfully completing the Basic Service Technician Digital Learning Course, you are now ready to progress to the skill based training phase of becoming a qualified Mares Service Technician. These courses are conducted by qualified Mares Lab Instructors and consist of comprehensive hands-on training exercises. During these courses you will have the opportunity to perform multiple service procedures on a wide variety of Mares products, including multiple complete regulator service overhauls on various Mares regulators. You'll also gain valuable experience in using the Mares Service Manual and Spare Parts Catalog during routine and special service procedures. Skill based training courses are designed to:

1. Provide comprehensive, real world, hands-on training about how to service and repair Mares products.
2. Enhance the knowledge gained from the Basic Service Technician Digital Learning Course.
3. Develop skills and abilities to the level required to successfully perform service and repair procedures on Mares products.
4. Prepare you for a successful full or part-time career as a Mares Service Technician.

SEMINARS 2019



• MARES SERVICE TECHNICIAN

This is by far the most popular of the skill based training courses. The all new and redesigned Mares Service Technician Training Course is a comprehensive 2 day training program that trains and qualifies individuals to service and repair Mares products. Topics include disassembly, reassembly and adjustment of in-line Mares regulators, service and repair procedures, troubleshooting, dive computers, Mares warranty, service guidelines and more. More than 12 hours of course time is dedicated to hands-on, skill based training on how to properly disassemble, reassemble and adjust Mares regulators and BC inflator mechanisms. **Successful completion of this course qualifies you to service and/or repair ALL Mares products.**

Prerequisite Requirements:

Completion of the Basic Service Technician Digital Learning Course.
Be currently affiliated with an Authorized Mares Dealer.
Be approved by the affiliated Mares Dealer to attend the course.

• MARES DIVING CENTER SERVICE TECHNICIAN

This course is designed for technicians who plan to work in a Mares Diving Center, such as a resort or diver training facility, that has limited or no retail sale of Mares equipment. Course duration is 1 day and provides skill based training related to the Mares Diving Center product line. Take this course if you plan to work in a Mares Diving Center and are interested in being able to service and repair your affiliated Mares Diving Center owned Mares products. **Successful completion of the Diving Center Service Technician Course qualifies you to service and repair ONLY your affiliated Diving Center OWNED equipment used in rental and/or training programs.**

Prerequisite Requirements:

Completion of the Basic Service Technician Digital Learning Course.
Be affiliated with an Authorized Mares Diving Center.
Be approved by the affiliated Mares Diving Center to attend the course.

• MARES SPECIALTY SERVICE TECHNICIAN

These courses are designed to train technicians to service and repair specific Mares products. Specialty Service Technician Training Course duration is approximately 1 day, depending on the course requirements and the number of products included in the course. **Successful completion of this course qualifies you to service and/or repair ONLY the specific Mares products for which you were trained.** These products will be listed on your qualification certificate. Contact your local Mares Subsidiary or Distributor for additional information on Specialty Service Technician Training Courses available in your area.

Prerequisite Requirements:

This varies according to the specific Specialty Service Technician Training Course requirements.
Authorization by a current Mares Dive Center or Mares Dealer.

• MARES SERVICE TECHNICIAN UPDATE

In order to maintain your Mares Service Technician qualification, you must attend the Annual Renewal Seminar within one (1) year* of completing a Service Technician Training Course or Annual Renewal Seminar. Annual Renewal Seminar is available online and/or as instructor led Update Seminars and are conducted regularly throughout the year, providing you with numerous opportunities to maintain your Mares qualification.

Update Seminar topics typically include new products, new and updated service procedures and a review of current Service Bulletins.
* Within one (1) year is defined as December 31st of the year in which the one year limit is reached.

Prerequisite Requirements:

Currently qualified as a Mares Lab Service Technician.
Qualification date is within the one (1) year update requirement.

THE MARES LAB TRAINING CYCLE®

The Mares Lab Training Cycle is a process that has proven effective in producing what we call "best in class results". This means that as a qualified Mares Service Technician, you can be confident that you've successfully completed the dive industry's most comprehensive dive equipment service and repair training program available through a dive equipment manufacturer. You can also be proud of the fact that you earned your qualification by demonstrating a "best in class" level of dive equipment service technician skills and abilities. Here's how the Mares Lab Training Cycle works:

Your Knowledge Development

Your basic dive equipment service and repair knowledge is established during your digital learning course and further enhanced during your skill based training course.

Your Skill Development

Your service and repair skills are enhanced during your skill based training course through a series of hands-on training exercises. Over 90% of the contact hours in these courses are dedicated to skill development.



Your Abilities Confirmed

Your knowledge and skill levels achieved through the Mares Lab training process are objectively evaluated and must meet the minimum core competency requirements in order to be qualified as a Mares Service Technician.

Your Abilities Improved

Your abilities improve over time by gaining additional knowledge and increasing skill levels. This is achieved through experience as a Mares Service Technician, by regular contact and communication with Mares Technical Assistance staff, by receiving periodic product updates and Service Bulletins and by participating in Service Technician Update Seminars.

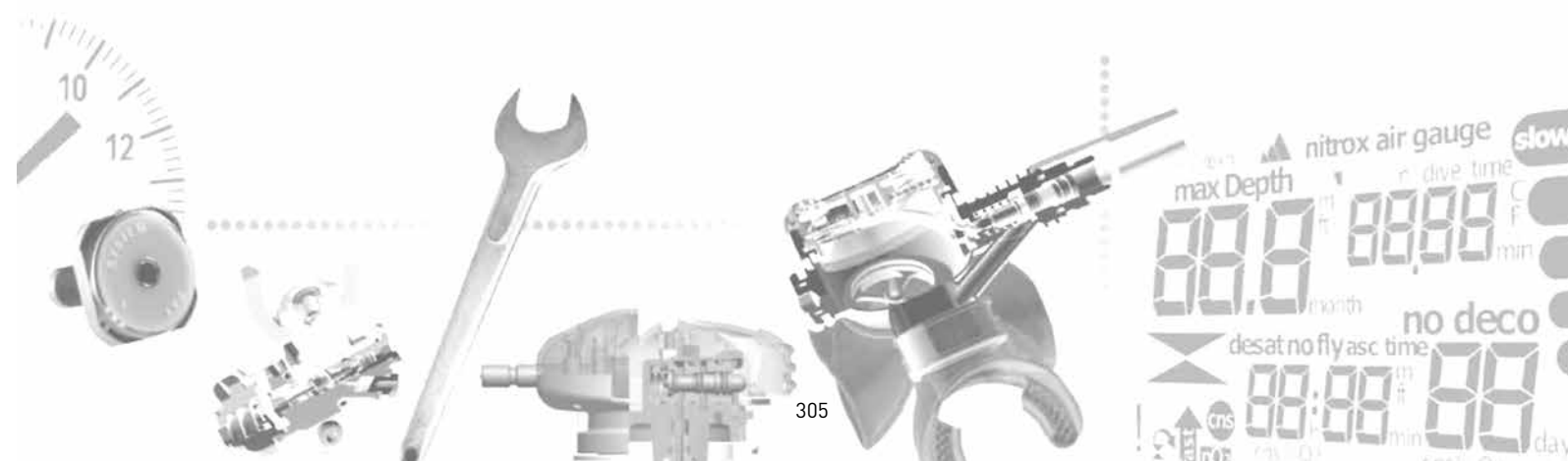

Product specifications and characteristics listed in this catalogue may be subject to changes by Mares without notice.

The trademark **mares**® is a registered trademark.

ISO 9001:2015 certified

mares



Mares S.p.A.
Salita Bonsen 4
P.O. Box 142
16035 Rapallo (Genova) · ITALY
Tel. +39 0185 2011 / fax +39 0185 201470
www.mares.com